

ROTHBUCHER SYSTEME

RS10

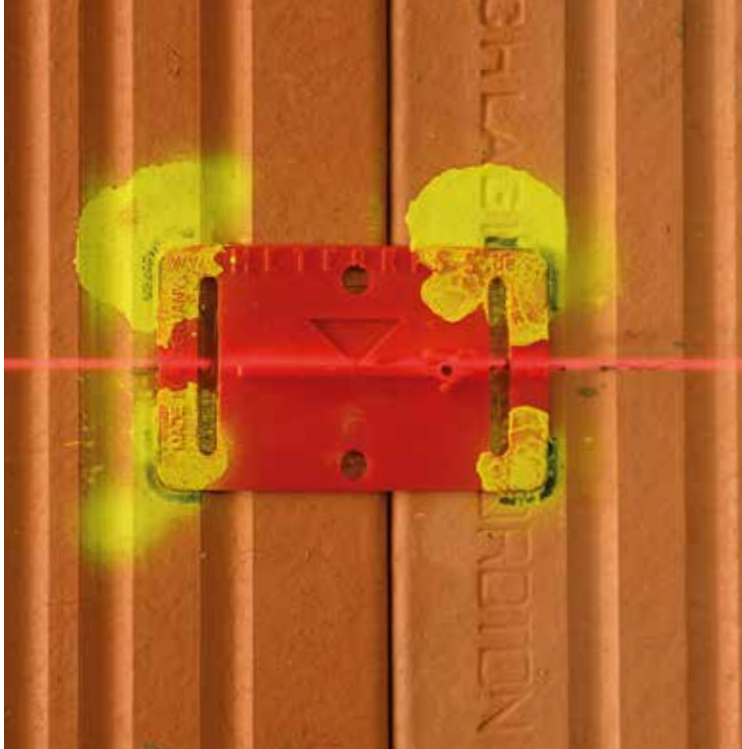

The RS Surveying Accessory System

Smart Surveying Solutions – Perfect for BIM and the Digital Construction Site
Request our Price List



Since 1996, Rothbucher Systems has been developing and selling products designed for documenting surveying points on construction sites. Over the years, our products have been successfully utilized in the fields of surveying, construction surveying, and monitoring.

High-precision instruments are indispensable to meet the high demands in surveying today. Therefore, pencil strokes, nails and other unidentifiable markers should be a thing of the past because they do not comply with the needs of modern surveying.

Precision starts with the surveying points. Only then can precision surveying instruments yield the expected results. This is also why our products are so much appreciated by surveyors, site managers, foremen and architects and now set a worldwide standard at many building sites.

Our system **“One reference point for all instruments”** was received with a flood of interest by the market. The system convinces with innovative solutions and easy handling. It sets new standards for reference points not only for the Digital Construction Site and BIM but also on all construction sites where modern surveying instruments are in use.

On our website www.smart-targets.com and on our **Rothbucher Systems YouTube channel*** we show a wide range of solutions and examples of use.

We are pleased to show you the versatility of our surveying accessory system in our new catalogue. On the following pages, you will surely also find the right product for your current project or suitable products to supplement your surveying instrument.

If you have any questions, please do not hesitate to contact us.











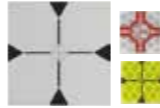

Georg Rothbucher

Founder and owner of Rothbucher Systems













*RS YouTube Kanal











Contents – 1 of 3

	Datum and Axis Markers RS10 to RS21	6 - 9
	Reflective Targets RSZ2 - RSZ6, RSZ22, RSZ2YE - RSZ6YE	10 - 11
	Construction Targets RS30 to RSAKZ6, Aluplate RSALU22	12 - 17
	Smart Angel Targets RS80 to RS100 RSAK80, RSAK130, RSAM80, RSAMG80	18 - 23
	Reflective Target with (swivel and) tilting function RS183 to RS193M	24 - 27
	Stake Out Aids RS95 to RS97, RS150M	28 - 31
	Mini Prisms RSMP10, RSMP12 and RSMP15	32 - 33
	Mini Prisms with tilting function RSMP380	34 - 35
	Reference point series with magnetic pot RSMF10 to RSMF16 and RSMS-X80	36
	Prisms for monitoring tracks and steel constructions RSMP380M and RSMP480M	37
	Mini Prisms with swivel and tilting function RSMP390M	38 - 39
	220 degree Mini Prisms RSMP480 and RSMP490M	40 - 41

Contents – 2 of 3

	Reference Points for GPS and GNSS RS090M to RS0195M	42 - 43
	Laser Scanner Targets RSL301, RSL496, RSL-X80, RSL-X90M RSL-X93M, RSL420M and RSL422M Laser Scanner Spheres RSLB10M and RSLB10SV	44 - 53
	Mobile Mapping-, Scanner- and Drone Targets RSL-X94M, RSL-X95M, RSL-X96M, RSL-X97M, RSL402 (DIBOND), RSL602M, RSL672M, RSL632M, RSL652M, RSL430, RSL452M and RSL453M (SLAM)	54 - 59
	Ground Control Targets for Drones RSL512, RSL520, RSL532, RSL572 RSL512XL, RSL532XL, RSL580 and RSL590M	60 - 65
	4/4 Boundary Markers RSKM10 to RSKM40 Fixed Point RSFP1 and Protection Cap RSFP1-A	66 - 67
	Track Machine Targets TMT10, TMT20, TMT25 and TMT30	68 - 69
	Laser Target, foldable RSLT10	70
	Coupler Adapter RSA-K480, RSA-K625 and RSA-K515-665	71
	Fixed Point System RSFP-X80	72
	RSFP-X80, RSMS1033, RSMS1062, RSMS-X80, RSSV-X80	73

Contents – 3 of 3

	Fixed Point System RSFP-X90 to RSFP-X99	74 - 77
	RSFP-X90, RSFP-X90-1+3, RSFP-X90-2, RSFP-X90-m6+m8	79
	RSFP-X90-30 to -39, RSFP-X90-5, RSFP-X99-5	80
	RSFP-X90-20+21, RSFP-X99-20+21, RSFP-X90-25+26, RSFP-X99-25+26	81
	RSSV-X90, RSSV-X99, RSFP-X97-2+3	82
	RSFP-X98-1+2	83
	RSFP-X99, RSFP-X99M, RSFP-X99-1	84
	RSFP-X99-11+12, RSFP-X99-70, RSFP-X99-73	85
	RSFP-X90-S40, RSPC90M	86
	Accessories	87 - 89
	Suitcase Sets KS1 to KS4	90 - 93



Ideal for concrete construction sites without plastering work and for permanent securing of axis as a negative imprint in concrete.



The negative imprints become visible on the ceiling after removing the ceiling formwork.

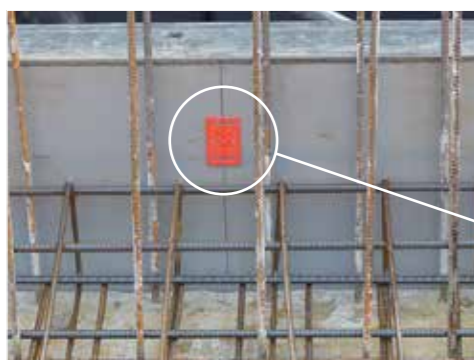

Datum and Axis Markers RS10 and RS11*



RS Datum Marker – proven millions of times – for good reason

The markers RS10 and RS11* are used to secure survey points on construction sites without plastering work and in door or window reveals.

To secure axis permanently until the building is completed, the markers are already measured and fastened in the slab formwork or the slab edge formwork on axis. The negative imprints, which are clearly visible for all trades, are used for the dry wall construction and any further inside installations.

The foreman uses the negative imprints at the ceiling edge to transfer the axis right to the freshly concreted ceiling with a string (chalk line) or laser. If required, they can later be used to install the façade.

Datum and Axis Markers RS10/RS11*
80 mm x 50 mm

All dimensioning files are available for download from our website



* self-adhesive

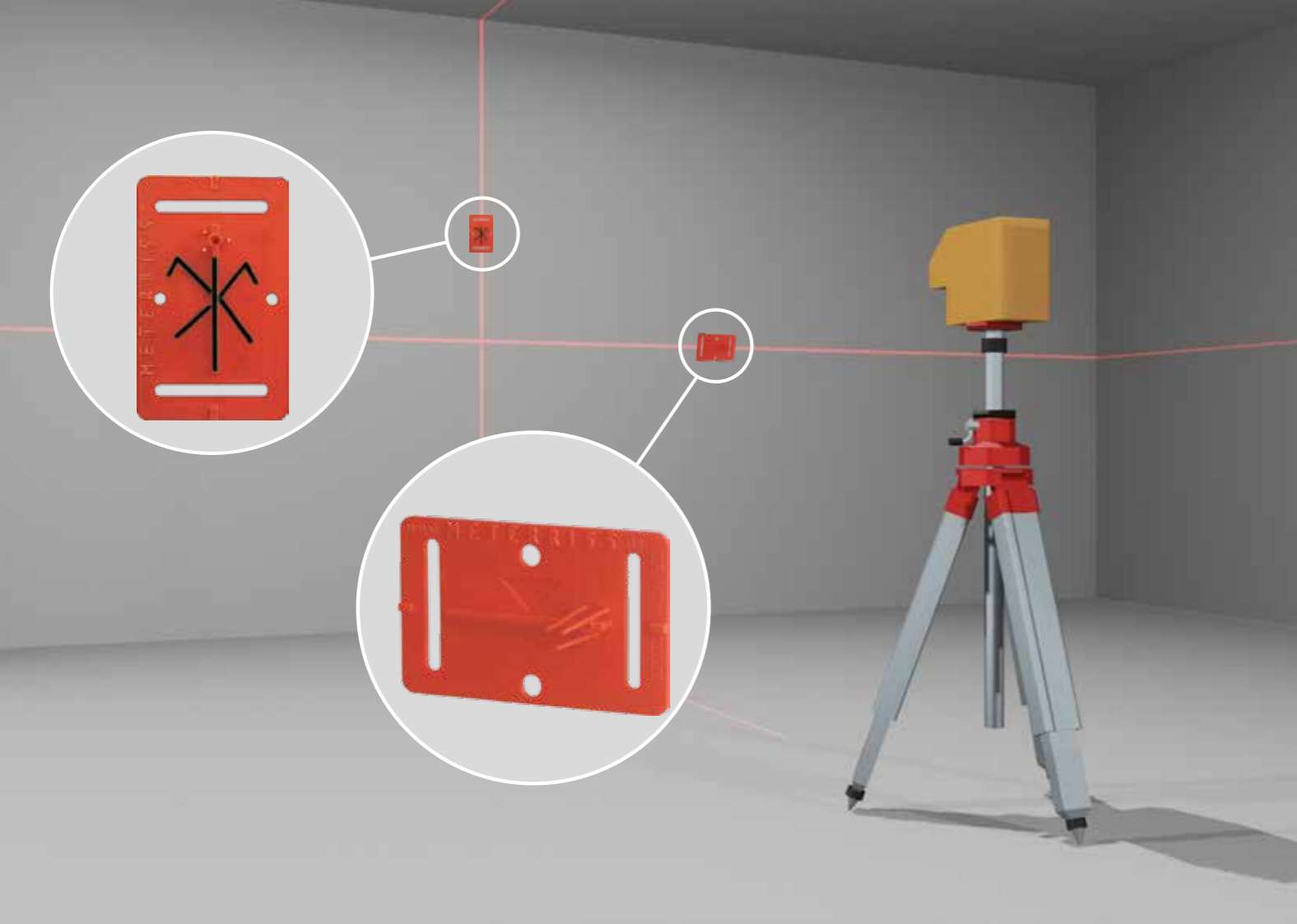

Datum and Axis Markers RS20 and RS21*



RS Datum Marker – proven millions of times – for good reason

The markers RS20 and RS21* are installed on unplastered or unrendered walls and serve as clear reference points for all trades. To avoid measurement differences during transfers, the markers are equipped with a protrusion to accurately align a measuring tape or rod.

The elastic “stubs” ensure that the datum point remains visible and retrievable even after plastering, securely maintaining heights and axes beyond the plastering phase. To prevent potential tampering, the corners of the markers are sprayed with color, making any intentional repositioning immediately noticeable.

After completing all work, the brushes are easily clipped off, requiring minimal finishing, while the markers remain embedded beneath the plaster as a permanent proof. For optimal installation, we recommend securing the markers with adhesive and additional fixation where needed.

We recommend gluing the markers and securing them at least once.

Datum and Axis Markers RS20 and RS21*
80 mm x 50 mm

All dimensioning files are available for download from our website



* self-adhesive

For secure marking of datum and axes on building sites with plasterwork.



RS21r* fixed to a column. The protrusion is cut in 4 - 5 times with a carpet knife.

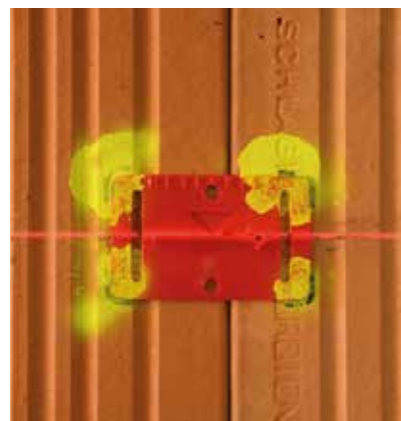

RS21r* glued, fastened, and sprayed over with colour to prevent tampering.



Elastic “stubs” to permanently ensure surveyed measurements are securely marked until after plastering work.

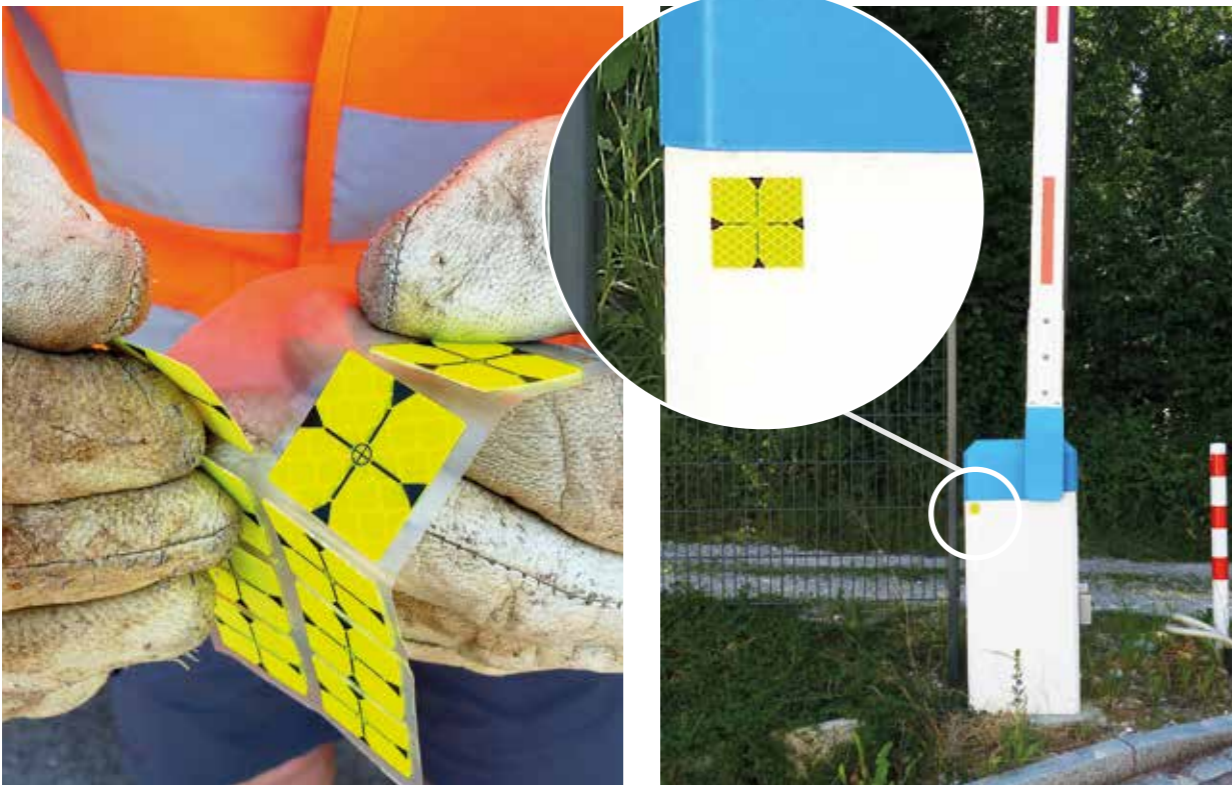

Gutters are not recommended for attaching reference points, as they are often unstable and narrow curves also have a negative effect on the accuracy of the measurement.

Reflective Targets RSZ2 - RSZ6, RSZ22, RSZ2YE - RSZ6YE

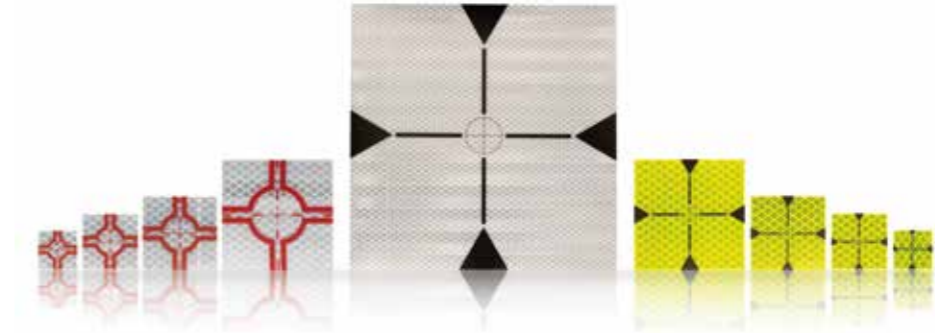

Reflective targets are available in the following sizes:

RSZ2 / RSZ2YE	21 x 21 mm	→ Range approx. 50 m
RSZ3 / RSZ3YE	30 x 30 mm	→ Range approx. 80 m
RSZ4 / RSZ4YE	40 x 40 mm	→ Range approx. 100 m
RSZ6 / RSZ6YE	60 x 60 mm	→ Range approx. 120 m
RSZ22	220 x 220 mm	→ Range approx. 500 m

The indicated ranges are average values, often exceeded by most modern measuring instruments. However, some devices require a minimum distance of 10 m.

Our reflective targets are provided on a carrier foil, ensuring easy removal even when wearing gloves.

To achieve an accuracy of 1 - 2 mm when measuring with reflective targets, the aiming angle should not exceed 20 degree.

For all distance measurements using total stations, we recommend exclusively using markers with reflective targets.

Markers with crosshairs, without reflective targets, are specifically designed for use with levels, theodolites, and general construction lasers.

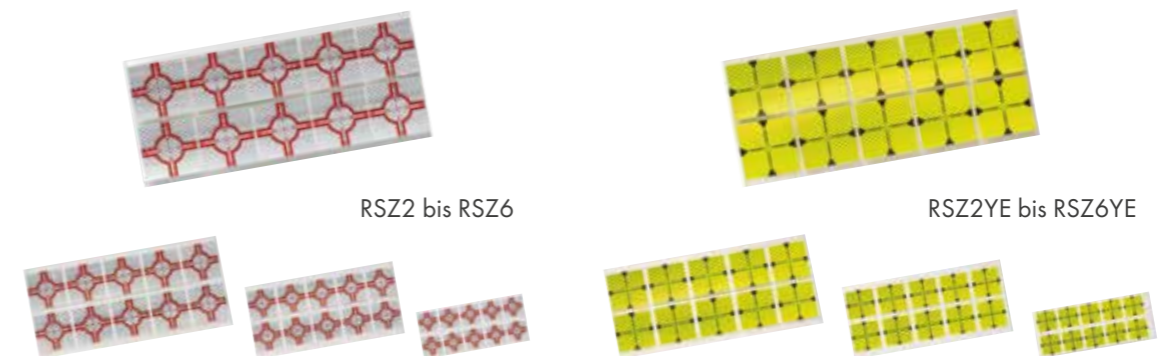



RS30r in industrial construction: documentation of heights and axes in one product.



RS30r in industrial construction: a perfect measuring point for each measuring instrument.

The height, axis and position number are indicated with number punch or water proof marker pen.



BIM Construction Targets RS30 and RS31*

RS40 and RS41*



Perfect reference points for BIM (Building Information Modeling)

- Unmistakable fixed points for all trades
- A fixed point for all surveying instruments currently used!

The targets RS30 and RS40 permit documentation and permanent security of heights and axes with a single product. If different measuring devices are at a construction site, the BIM targets are the best solution to avoid measuring differences.

Whether leveling instrument, laser, theodolite, or total station: The BIM Construction Targets provide the optimal reference point for each instrument and ensure identical heights, axes, and coordinates across all trades.

On difficult surfaces, the markers are permanently fastened with adhesive or with plugs and screws. A protrusion where a meter ruler or measuring rod can be placed guarantees the exact measurement of the height.

Crosshairs are imprinted on the backing plate under each reflective target to ensure the survey point is durably marked. Should the reflective target be damaged, its replacement is no problem. There is thus no loss of the original survey point and the uniqueness and durability of the survey point in accordance with BIM are guaranteed.

BIM Construction Targets RS30 & RS31* with reflective target 30 x 30 mm
90 mm x 60 mm

BIM Construction Targets RS40 & RS41* with crosshair
90 mm x 60 mm

All dimensioning files are available for download from our website



* self-adhesive

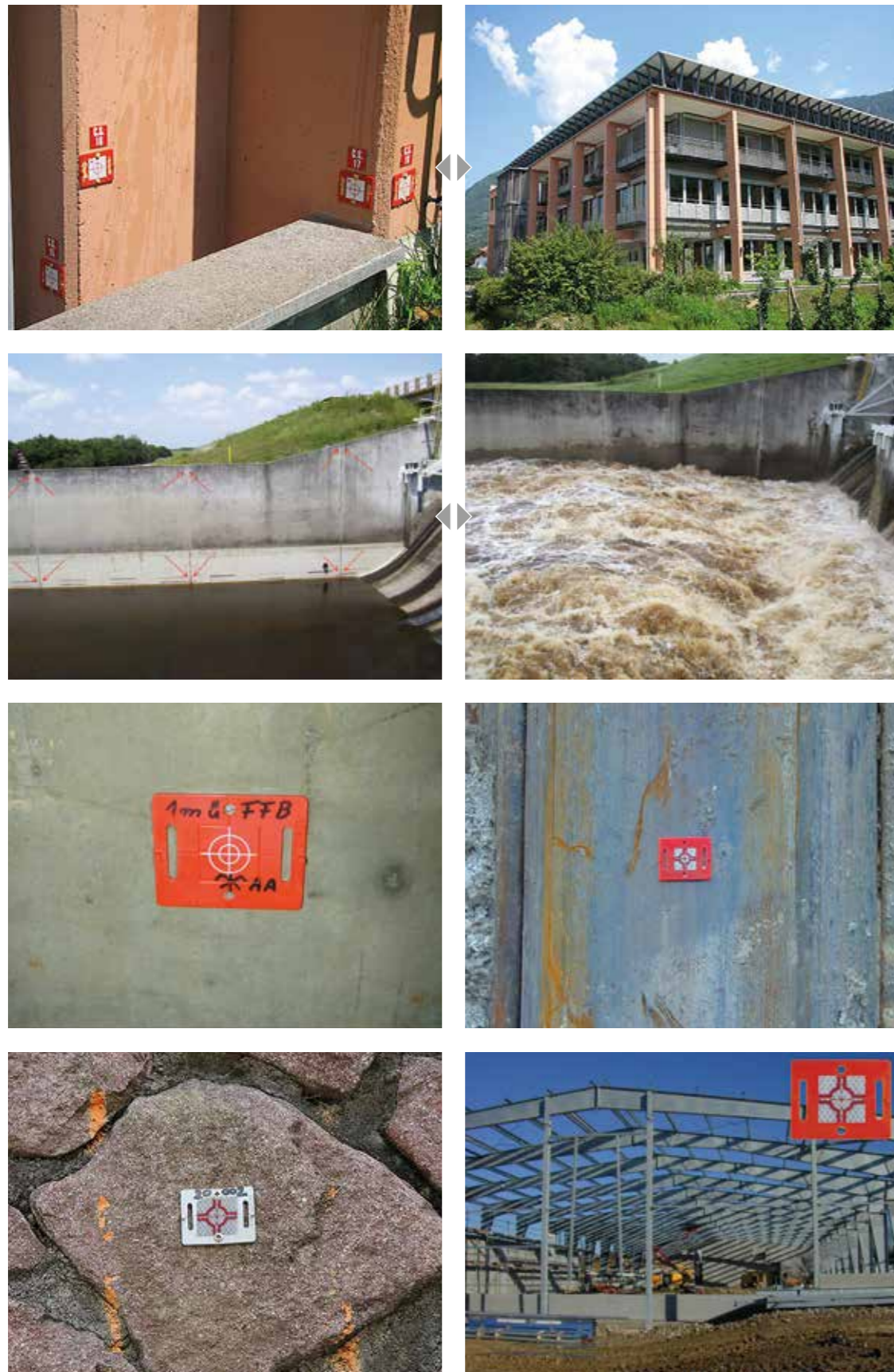

Smart targets for diverse applications

Smart Targets

RS50 / RS51*

RS60 / RS61*

RS70 / RS71*



Reference points for BIM and even more

These markers offer a wide range of applications and fully comply with all requirements for use on BIM-compliant construction sites.

In outdoor areas, they can be permanently fixed at any desired point and primarily serve as reference points for stationing with total stations or for settlement measurements. Indoors, they clearly document heights and axes. Axes can be transferred to the next floor easily and accurately using a laser or plumb line in stairwells or through an opening.

When fixed to façades, the Smart Targets can continue to be used by surveyors and foremen and are utilized by façade installers for aligning glass and stone façades. Due to their material quality and durability, the Smart Targets are also excellent for long-term monitoring of buildings, bridges, retaining walls, and more.

To ensure the survey point remains secure over an extended period, each reflective marker features a crosshair imprinted on the backing plate. If the reflective target is damaged, it can be easily replaced, allowing the original survey point to be restored quickly, easily, and cost-effectively.

Smart targets RS50/51* with reflective target 30 x 30 mm
75 mm x 60 mm

Smart targets RS60/61* with reflective target 40 x 40 mm
75 mm x 60 mm

Smart targets RS70/71* with crosshair
75 mm x 60 mm

All dimensioning files are available for download from our website



* self-adhesive



Arabtec Resident Tower
Dubai



Highway bridges A94



Schellingwoude Bridge
Amsterdam



Highway bridges A8



Smart Target RSAKZ6



Aluplate RSALU22

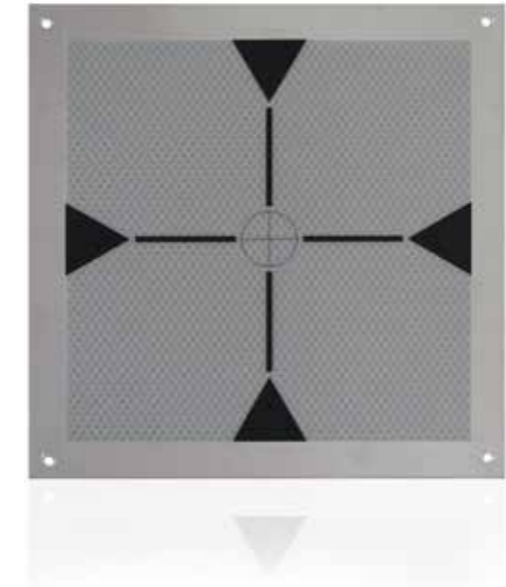

Precision over long distances

These Smart Targets are used whenever measurements over longer distances are required.

The RSAKZ6 targets feature a 60 x 60 mm reflective target and offer a range of approximately 120 m, or up to 250 m and beyond in reflectorless mode.

The RSALU22 panels, made with a 260 x 260 mm aluminum plate and equipped with a 220 x 220 mm reflective target, are suitable for measurements up to 500 m.

Carrier plate RSAKZ6 with reflective target 60 x 60 mm
120 mm x 75 mm

Aluplate RSALU22 with reflective target 220 x 220 mm
260 mm x 260 mm

All dimensioning files are available for download from our website





Subway Station, World Trade Centre in New York City



RS90r, Subway Station, World Trade Centre



RS90g, Metro Rotterdam



RS80r, Al Sadd Stadium in Qatar



Al Sadd Stadium in Qatar

Smart Angle Targets

RS80

RS90

RS100

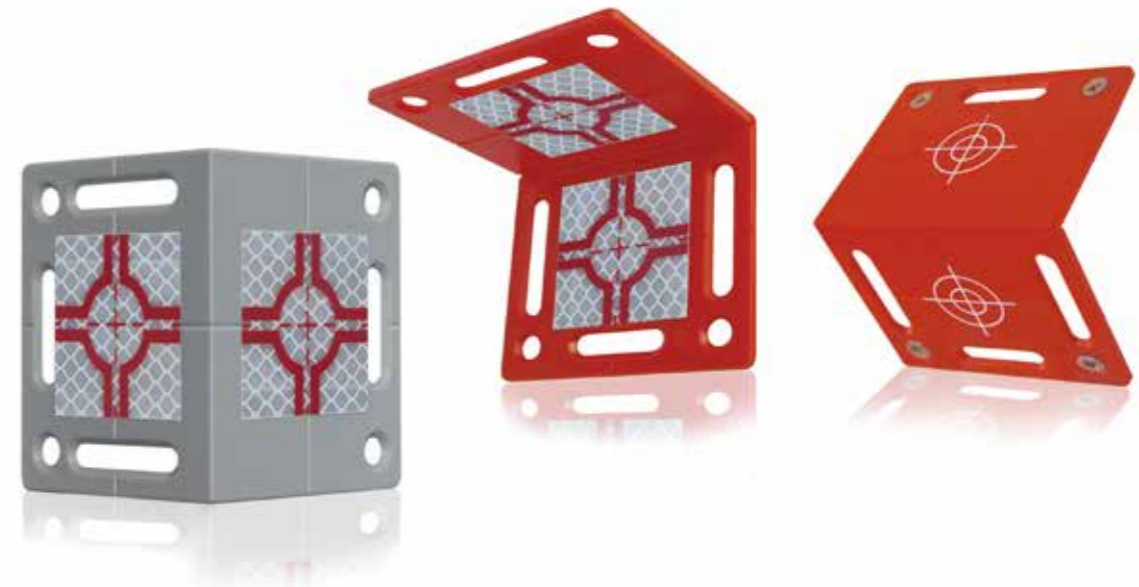

Solutions for challenging positions

These Smart Targets are used in situations where direct aiming at survey points is no longer possible due to difficult measurement positions.

The RS80 targets are mounted in a "gable-shaped" configuration and are particularly well-suited as corner solutions for observing façades and other structures.

When transferring heights and axes from outside to inside or vice versa, the RS80 targets can be installed on window reveals to facilitate measurements "around the corner."

The RS90 targets enable survey points to be aimed at from almost any position, allowing an axis to be targeted, for example, from the front, below, or above.

To ensure the survey point remains secure over time, each reflective target features a crosshair imprinted on the backing plate.

**Smart Angle Target RS80 with two reflective targets 40 x 40 mm
90 mm x 75 mm**

**Smart Angle Target RS90 with three reflective targets 40 x 40 mm
75 mm x 65 mm**

**Smart Angle Target RS100 with four crosshairs
90 mm x 75 mm**

All dimensioning files are available for download from our website





Monitoring on railway tracks. Easy fixing is guaranteed with our construction glue RSMK-Fix.

Mounting Plates with Angles and Reflective Targets RSAK80 RSAK130



Monitoring made easy

The RSAK80 and RSAK130 products are used in applications such as railway tracks, bridges, enclosures, dams, buildings, supports, high-bay warehouses, elevator shafts, and more.

With carefully planned installation, these products allow the survey point to be targeted from almost any position. For example, along **railway tracks**, surveyors no longer need to enter hazardous areas and can perform measurements safely at any time. Similarly, dangerous and costly road closures are no longer necessary, as many measurements become significantly easier.

In **elevator shafts**, the adapters are mounted vertically on axis (see image, left). This ensures that axes are visible and accessible from any position for all trades.

To ensure the long-term security of the survey point, a crosshair is imprinted on the mounting plate beneath each reflective target.



Surveyors no longer need to enter danger areas.

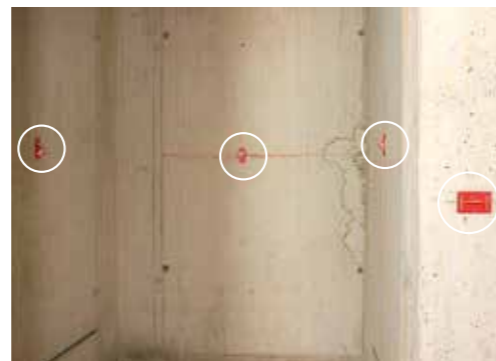

RSAK130 and RS21: perfect reference points for FFL and axes in the area of elevator shafts



Observation of sound barrier walls



Observation of bridges

RSAK80 – Carrier Plate with reflective targets 40 x 40 mm
120 mm x 75 mm

RSAK130 – Plate with angle and two reflective targets 30 x 30 mm
100 mm x 35 mm

All dimensioning files are available for download from our website





**Targets with the Special Clip System
RSAM80 RSAMG80**



Stainless steel adapter

The Clip makes the difference

To secure reference points for decades, these targets are offered with the **RS-Clip system**. Reference points that become unusable due to weather conditions or damage can be restored quickly and cost-effectively, ensuring the original reference point remains intact.

The adapters are available with or without a DW15 thread. Depending on the requirements and planned duration of use, the components can be glued, welded, or screwed into existing anchor sleeves.

For example, on bridges where anchor sleeves are installed in the cantilever arm, the targets can be directly screwed into the existing anchor sleeves and used for bridge monitoring.

For new supports and walls, anchor sleeves can be strategically planned and installed to ensure long-term monitoring after project completion. The result is **reference points with exceptional durability!**

For additional solutions designed for long-term measurements over decades, greater distances and with even higher precision, see pages 74 to 86.

- Adapter RSAM80 with reflective targets 40 x 40 mm 125 mm x 125 mm
- Adapter RSAMG80 with DW15 thread with reflective targets 40 x 40 mm

All dimensioning files are available for download from our website



Survey point on the ski lift support



Coen Tunnel Amsterdam



Bridge monitoring (Tappen Zee Bridge USA)

Reflective Target with Tilting Function RS183



More precision from every direction

The RS183 reflective target can be precisely aligned with the instrument when using total stations and tilted up to 180 degree, enabling the same survey point to be used from various directions. Combined with the RSFP-X80 fixed point, the target can be “clicked into position” in two orientations, allowing the survey point to be aimed at from almost any direction (see image series on the left).

When installed around the construction site prior to the start of work, foremen or surveyors can use the same survey point from the foundation pit to the top floor. As construction advances, the reflective target can be easily adapted to the evolving construction process.

The integrated plug-in system allows multiple targets to be combined, enabling measurements from different directions without having to rotate the reflective targets. The distance between the survey points of the combined targets is always 60 mm.

Installation is quick and easy, even on challenging surfaces, using mounting adhesive.



RS183 with reflective target 30 x 30 mm
 Offset: 0
 Tilting axis height: 30 mm



All dimensioning files are available for download from our website



The simple and quick installation on any surface makes the RS183 targets particularly user-friendly. Since the RSFP-X80 fixed point is designed for the targets to be clicked precisely into a centered position in two directions, the same survey point can be used from almost any direction.



RS193M* with fixed point RSFP-X90 on the batter board. In this case the fixed point rotates exactly on the axis.

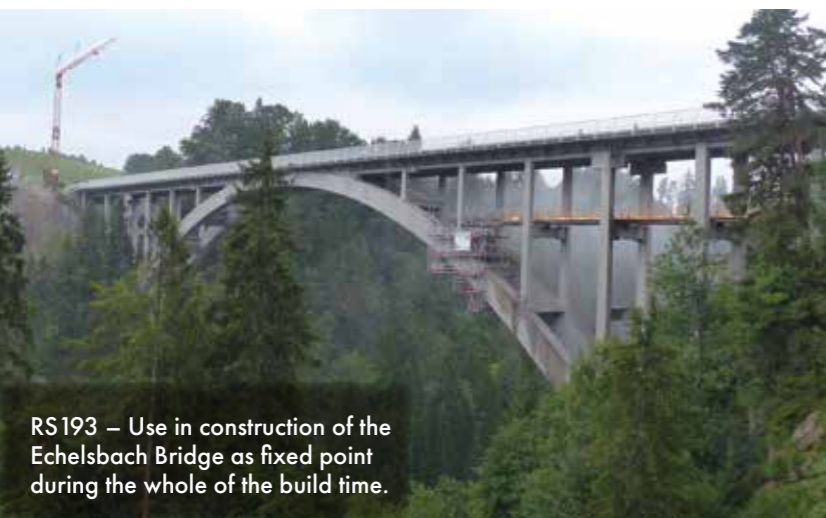

RS193 – Use in construction of the Echelsbach Bridge as fixed point during the whole of the build time.



Example of the use of RS193rM* as a fixed point on different surfaces and for the exact alignment of the drill carriage.

Target and Reflective Targets RS192M* RS193 and RS193M*



Target and Reflective Target with swivel and tilting function

These targets are 360 degree rotatable and can always be precisely aligned with the instrument, allowing the same survey point to be used from any direction.

In combination with a fixed point from the RSFP-X90 to RSFP-X99 system, the RS192M* and RS193M* targets can be removed and later reinstalled on the exact same survey point (see pages 74 to 86).

The RS192M* target is ideal for stationing and measurements with devices such as Leica 3D Disto, GeoMax Zoom 3D, and Flexijet 3D.

If needed, the specially designed RSPC20 protective cap reliably shields the targets from dirt and weather conditions.

A product from the series "One Point Fits All" – One reference point for all instruments

- RS192M* with non-reflective target 20 x 20 mm
- RS193 and RS193M* with reflective target marker 30 x 30 mm
- Range approx. 80 m
- Offset: 0
- Tilting axis height: 45 mm

All dimensioning files are available for download from our website



* magnetic



RS95 – Stake out work on the batter board

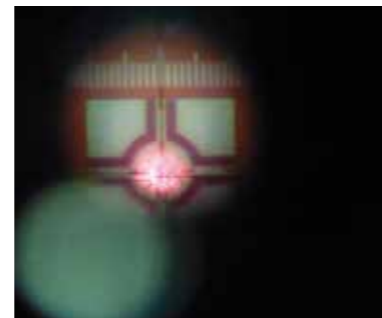

RS96 – Stake out work on the floor slab

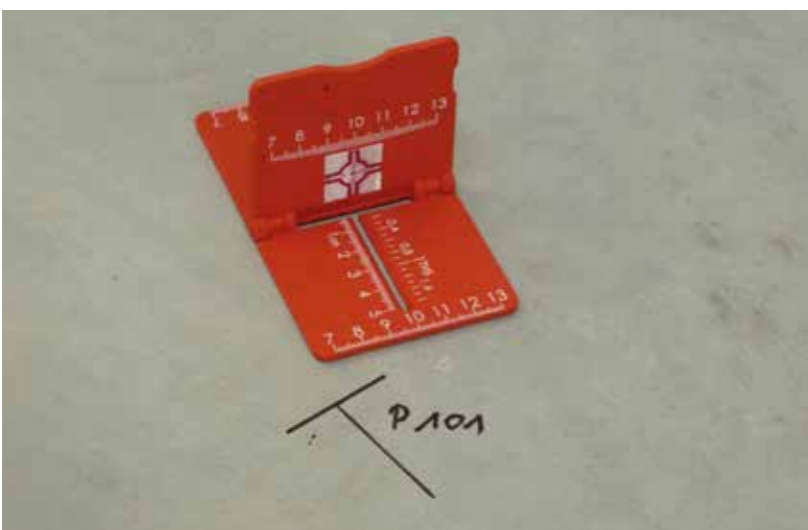

Stake Out Aids RS95, RS96 with Reflective Target and RS97 with Non-reflective Target



Stake out faster and more precisely

The stake out aids RS95, RS96, and RS97 are specifically designed for precise stake out tasks at batter boards and on floor slabs. Particularly in the “final phase”, during the last 5 - 10 cm, measuring survey points on concrete or floor slabs can be challenging, as the prism pole requires frequent adjustments and must be held perfectly vertical – a time-consuming process. The stake out aids significantly simplify this task: they can be placed directly on the ground and by using the measurement scales, the assistant can quickly and accurately follow and transfer the surveyor’s directional instructions.

Advantages of the stake out aids:

- Simplifies the measurement of axes at batter boards.
- Enables quick and precise measurements on concrete and floor slabs.
- Facilitates the accurate transfer of the surveyor’s directional instructions.
- Eliminates the need for precise vertical alignment of the prism pole.
- Features orientation scales for left and right (the number 10 corresponds to the axis).
- Includes orientation scales for forward and backward alignment.
- Foldable design: Fits in any shirt pocket or instrument case! (RS96/RS97)
- After minimal practice, significant time savings can be achieved.

Stake Out Aid RS95 with reflective target 20 x 20 mm
Target height: 30 mm

Stake Out Aid RS96 foldable with reflective target 20 x 20 mm + ruling lines
Stake Out Aid RS97 foldable with non-reflective target 20 x 20 mm + ruling lines
Target height RS96 and RS97: 20 mm

All dimensioning files are available for download from our website





Staking out with the Stake Out Aid for Robotic Total Stations RS150M*



Move the stake out aid on the base plate until the target position is reached – visible on the green circle.



Slide the prism to one side and mark the target position with a pencil.

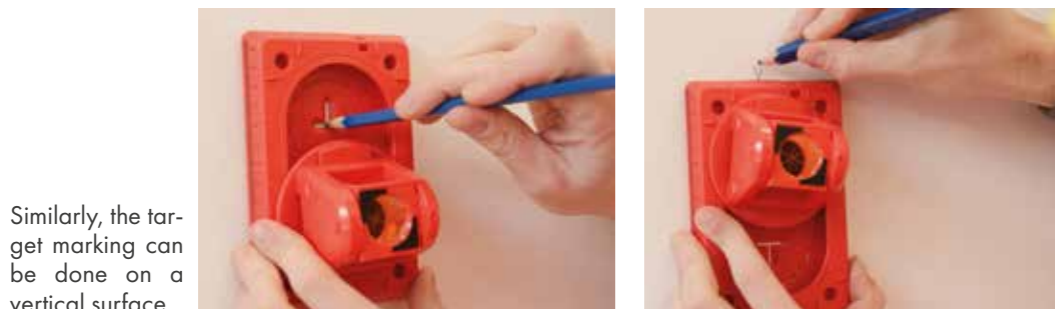

Similarly, the target marking can be done on a vertical surface.

Fast transfer of heights with set height offset of 50 mm in the total station.

Stake Out Aid for Robotic Total Stations RS150M*



The most valued stake out aid

An innovative new solution for staking out measuring points quickly and accurately on horizontal or vertical surfaces using robotic total stations.

After reaching the point to be measured, the particular measuring point is revealed directly below the prism by simply sliding the prism from position A to position B and vice versa, and can be marked directly via a cavity in the base plate.

Advantages:

- Precise and fast setting out
- Facilitates direct marking on the ceiling using the stake out aid upside-down
- Direct marking of the point to be measured on horizontal and vertical surfaces
- With a 50 mm height offset set in the total station, heights can be marked directly at the top and bottom edge without moving the prism.
- Prism always remains aligned to the instrument
- Paying attention to a horizontal position by means of a spirit level is not necessary, as the tilting axis height is only 50 mm.
- The RS150WB bubble level is included for straight markings on walls.
- Fast transfer of heights with set height offset of 50 mm in the total station.

On *YouTube/Rothbucher Systeme* we show how easily and quickly points can be staked out.

Stake Out Aid RS150M*
Offset: -16,9 (Leica +17,5)
Tilting axis height: 50 mm

All dimensioning files are available for download from our website



* magnetic



Mini Prisms RSMP10, RSMP12 and RSMP15



Our smallest prisms for special cases

RSMP10 with 12.7 mm and RSMP12 with 17.5 mm mini prism

When using the mini prisms RSMP10 and RSMP12 for settlement measurements, the spikes can be removed and thus be inserted or glued into the smallest cracks or holes. On façades, historical buildings, supports and lots of other objects, monitoring is possible with measuring points that are barely identifiable by the general public. At concrete or masonry objects, small holes can be drilled to countersink the prisms flush with the surface.

With these mini prisms surveyors can measure in gaps, holes and corners easily and quickly. Fixed dimensions (see product drawings) give the surveyor the exact path from the point of measurement to the base of the housing or the tip of the spike. In forensics, the use of prisms include the exact surveying of bullet holes.

PLEASE NOTE: For precise measurements, the prism must be exactly aligned with the surveying instrument!

RSMP10 with Ø 12.7 mm mini prism: offset -5.6 (minus 5.6) [Leica +28.8]

RSMP12 with Ø 17.5 mm mini prism: offset -5.4 (minus 5.4) [Leica +29.0]

RSMP15 with Ø 12.7 mm mini prism: offset -5.6 (minus 5.6) [Leica +28.8]

Angle Plate RSMP15 with 12.7 mm mini prism

For quick mounting, RSMP15 with 12.7 mm mini prism is easily glued, even to difficult surfaces such as marble façades, historic buildings, steel work, rail tracks, gas and oil pipelines.

When using robotic total stations:

- Permanent settlement monitoring can be carried out during the building work
- Settlement measurements on railway tracks are possible while under the load of rail traffic
- Bridges and other structures can be monitored even more quickly and precisely

The prisms can be used at an angle of up to 25 degree.

In the event of problems with the angle or when measuring from greater distances, we recommend our tilting mini prisms – see following pages.

All dimensioning files are available for download from our website



RSMP15 Hearst Castle USA



RSMP15 for surveying with robotic total station while under load



RSMP10 can be placed in the smallest gaps.



RSMP12 – almost invisible to passers-by



See page 72
**FIXED POINT
 SYSTEM**
 RSFP-X80

Mini Prisms with Tilt Function RSMP380

Proven Precision:
 "White Paper"
 on these products
 available!



Mini Prisms RSMP380 with silver or copper coated Ø 25.4 mm prism

When using these mini prisms, the measuring points can always be exactly aligned with the measuring instrument and turned through 180 degree. This enables the same survey point to be used from different directions. Bridges, façades and lots of other objects can thus be monitored more quickly and precisely. The integral plug-in system enables prisms to be combined with one another, permitting surveying from different directions without needing to rotate the prism.

Using the mounting plate RSFP-X80, you can easily fix the prisms, even on difficult surfaces, by means of our RSMK-FIX mounting adhesive. After completion of the survey, they can be removed quickly and easily and, if need be, re-affixed. The mounting plate RSFP-X80 is designed in a way so that the prisms can be clipped in – exactly centered – in two directions. The same survey point can thus be used from almost all directions. If the mounting plate RSFP-X80 is used in high-vibration environments (e.g. if mounted on railway tracks), the prisms can be secured to the mounting plate with small screws.

If necessary, fastening them with screws is also possible.

With mini prism RSMP380, ranges up to 600 m can be achieved in ATR mode. The ranges depend on the survey instrument and are influenced by weather and ambient conditions.

RSMP380 with Ø 25.4 mm mini prism:
 Offset: -16.9 (minus 16.9) [Leica +17.5]
 Tilting axis height RSMP380: 30 mm

All dimensioning files are available for download from our website



RSMP380 with Fixed Point RSFP-X80g

Easy and quick setup on any surface, avoiding unnecessary or undesirable drilling

Reference point series with magnetic pot RSMF10* to RSMF16* and RSMS-X80*



The RSMF10* to RSMF16* reference point series with magnetic pot offers an easy and fast way to set reference points on steel. This series enables precise and efficient placement of reference points in metal construction marine construction, on steel structures, masts, columns, and various other applications.

Installation step by step:

- Attach the target or prism with the pot magnet in the desired location where the reference point is planned and then remove again so that the magnet remains on the surface.
- Use a waterproof pen to mark a point through the hole in the center of the magnet or once around the magnet so that the exact position can be found again later.
- Then place the target on top and it is ready for use. The RSMP380 prisms can be aligned in all directions.



Reference Point Series with Magnetic Pot Set RSMS-X80 – In this version, the magnet itself serves as the reference point. Prisms and targets can be rotated in any direction and easily attached or removed. After removing the prisms or targets, the magnet with the magnetic pot remains as the reference point and can be reliably protected from dirt with the protective cap RSPC-X80.

Both solutions enable quick and easy setup of highly precise reference points on steel, suitable for both surveying and monitoring applications.



* magnetic

Prisms for track monitoring and steel construction RSMP380M* and RSMP480M*

Proven Precision:
"White Paper"
on these products
available!



Specifically for **monitoring tracks and steel constructions**, we offer a magnetic version of our RSMP380 and RSMP480 220 degree prisms.

Advantages:

- No need to use glue
- Uniquely quick installation – even on wet surfaces.
- No need to clean the surface.
- Option to replace the prism or magnet as needed

The prisms have been tested in all weather conditions and have consistently proven their reliability thousands of times.

Caution: At temperatures above 80 degrees Celsius (176 degree F), the magnets may lose their adhesive force.

If such high temperatures are possible on the surface in your area of application, we recommend adding a little glue or generally gluing the prisms.

For mounting prisms using glue (e.g. RSMK-Fix adhesive), we have developed our RSFP-X80 adapter. Even with this installation method, the prisms can be used multiple times.

With mini prism RSMP380M, ranges up to 600 m can be achieved in ATR mode, with the RSMP480M up to 300 m. The ranges depend on the survey instrument and are influenced by weather and ambient conditions.

RSMP380M* with Ø25.4 mm mini prism: Offset -16.9 (minus 16.9) [Leica +17.5]

RSMP480M* with 220 degree Mini Prism: Offset 0 (null) [Leica +34,4]

Magnet (including connecting screw) and prism can be ordered separately



* magnetic





Monitoring of HMS Victory in the Historic Dockyard, Portsmouth

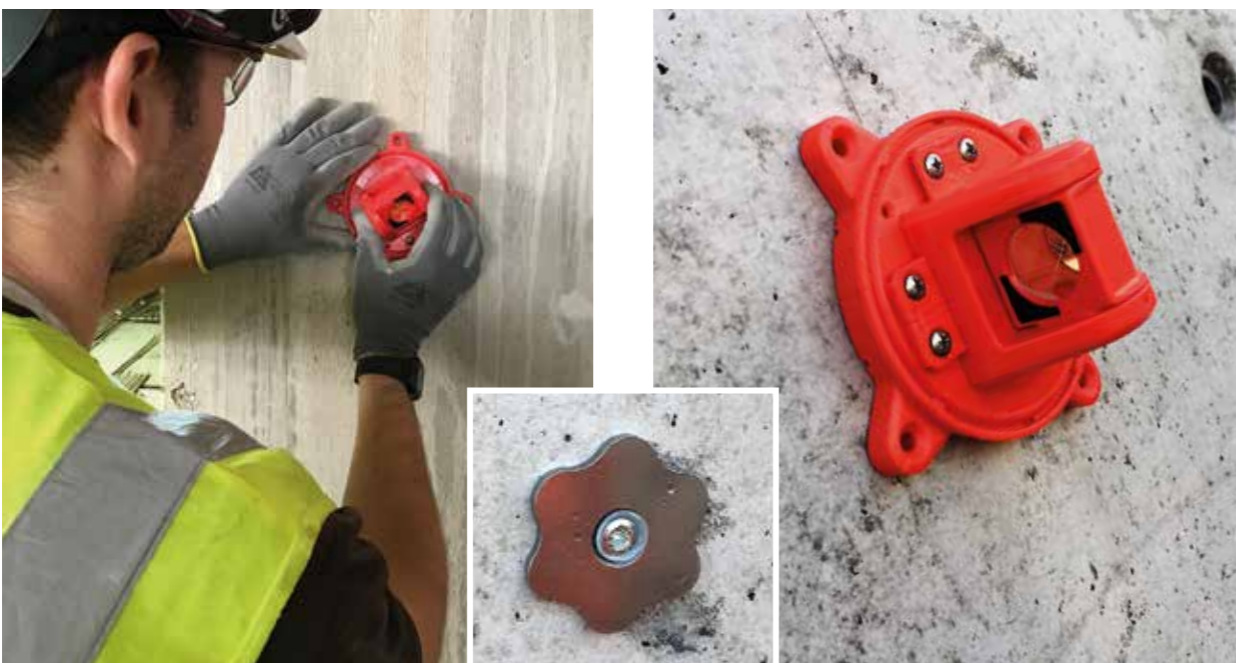

RSFP-X90 (small picture, centre) as restore point for mini prism RSMP390rM*

Mini Prisms with Swivel and Tilt Function RSMP390 and RSMP390M*

See pages 74-77
**FIXED POINT
SYSTEM**
RSFP-X90 to -X99

Proven Precision:
"White Paper"
on these products
available!



Mini Prism RSMP390 and RSMP390M* with silver or copper coated, Ø 25.4 mm prism

An extensive range of accessories are available for mounting prisms on different surfaces. Solutions for all kinds of mounting requirements on concrete, glass, rocks, historic buildings, oil and gas pipelines, metal and many other difficult surfaces are part of the standard repertoire – see pages 74 to 86.

When using total stations or robotic total stations:

- The prism can always precisely be aligned with the survey instrument.
- The prism can be rotated through 360 degree, enabling the same survey point to be used from almost any direction.
- Bridges, façades and many other objects can thus be monitored more quickly and precisely.
- Permanent settlement monitoring can be carried out during the building work.
- The OPFA system enables long-term monitoring over decades.

A product from the series "One Point Fits All" – One reference point for all instruments

With mini prism RSMP390(M*), ranges up to 600 m can be achieved in ATR mode. The ranges depend on the survey instrument and are influenced by weather and ambient conditions.

When sighting survey points that are already known, ranges of up to 1000 m can be achieved with robotic total stations! For measurements in manual mode, depending on the focus, ranges of approx. 200 m can be obtained.

RSMP390(M*) with Ø 25.4 mm mini prism:
Offset: -16.9 (minus 16.9) [Leica +17.5]
Tilting axis height for RSMP390(M*): 45 mm

All dimensioning files are available for download from our website



* magnetic



See pages 72-77
**FIXED POINT
 SYSTEM**

RSFP-X80 +
 RSFP-X90 to -X99

220 degree Mini Prisms RSMP480 and RSMP490M*

Proven Precision:
 "White Paper"
 on these products
 available!



A prism that sets standards

- Enables reference points to be located from virtually any direction
- Thanks to the RS range of accessories, quick and easy mounting on almost all surfaces is guaranteed – see accessories pages 72 to 89.
- Also available as version RSMP480M* for track monitoring (page 37)

Based on experience, aiming the prisms in ATR mode delivers the best measurement results. Accuracy levels of approximately ± 1 mm are often achieved.

The combination of easy mounting on almost all surfaces with our accessories and the possibility of being able to use the measuring point from all sides makes these prisms something special.

A unique feature in surveying is the ability to rotate the 220 degree prisms along their axis. This allows the reference point to be used horizontally, vertically, and even at an incline, which is e.g. helpful in ramp construction.

With mini prisms RSMP480 and RSMP490M, ranges up to 300 m can be achieved in ATR mode. The ranges depend on the survey instrument and are influenced by weather and ambient conditions.

A product from the series "One Point Fits All" – One reference point for all instruments

RSMP480 with 220 degree Prism:
 Offset: 0 (zero) [Leica +34.4]
 Tilting axis height: 30 mm

RSMP490M* with 220 degree Prism:
 Offset: 0 (zero) [Leica +34.4]
 Tilting axis height: 45 mm

All dimensioning files are available for download from our website



* magnetic



RSMP490M

Easy fixing with maximum flexibility leave nothing to be desired. One prism for many applications!



RSMP495M



RSMP480M



See pages 74-77
FIXED POINT SYSTEM
 RSFP-X90 to -X99

Reference Points for GPS and GNSS RS090M*, RS0190M*, RS095M* and RS0195M*



The reference points RS090M*, RS0190M*, RS095M*, and RS0195M* have been **specifically developed for use with GPS and GNSS antennas as well as antenna poles**. Combined with the OPFA system, they offer even more possibilities to optimize the use of your instruments.

Advantages of using these reference points with GPS and GNSS:

- **Establishing Fixed Points:**
 Fixed points with a GNSS antenna if an accuracy of less than 1 cm is sufficient. The reference points can subsequently be used with total stations, laser scanners, drones, and other instruments.
- **No Need to Drive Nails:**
 Instead, existing reference points are used, or new ones can be quickly and flexibly set with the RSFP-X90 to RSFP-X99 fixed point system. This provides significantly more mounting options compared to traditional nails:
 - Gluing • Screwing • Magnetic attachment
 - Additional options are detailed in "One Point Fits All" – OPFA.
- **Vertical Objects:**
 Fixed points can also be established on vertical surfaces (e.g., walls) using GNSS / GPS Receiver with tilt compensation
- **Seamless Workflow:**
 Supports various measurement techniques: GNSS – Laser Scanning / Lidar – Photogrammetry – Total Stations – Laser Tools (line and rotation lasers).

A product from the series "One Point Fits All" – One reference point for all instruments

RS090M* and RS0190M*:
 Offset: 0 (zero)
 Tilting axis height: 45 mm

Extra strong magnetic base
 page 51

RS095M* and RS0195M*:
 Offset: 0 (zero)
 Tilting axis height: 100 mm



The perfect accessory for your GNSS / GPS antenna: Fixed points RS090M* to RS0195M*, the reference point system RSFP-X90, ground marker spike RSFP-X97-2 + -3, and floor stand RSFP-X98-2.

All dimensioning files are available for download from our website



* magnetic

Laser Scanner Target RSL301*

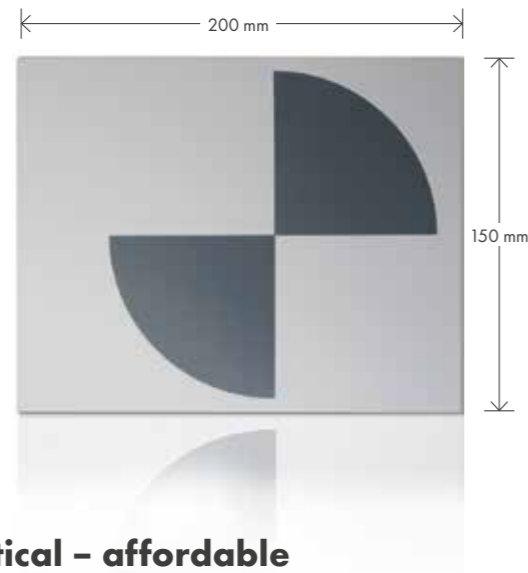

Simple – practical – affordable

- Self-adhesive – can be reused multiple times on smooth surfaces
- Suitable for indoor and outdoor use, waterproof, UV-resistant
- Quickly and easily mounted
- Provide fixed points for linking multiple viewpoints
- For the assignment of spatial reference information to a geospatial data set

RSL301*

Ideally suited for use with scanners from Leica, GeoMax, Faro and ZF.

These targets are self-adhesive and can be used multiple times on smooth surfaces. For outside, we recommend using an extra adhesive. A labelling field facilitates clear assignment of the measuring points.

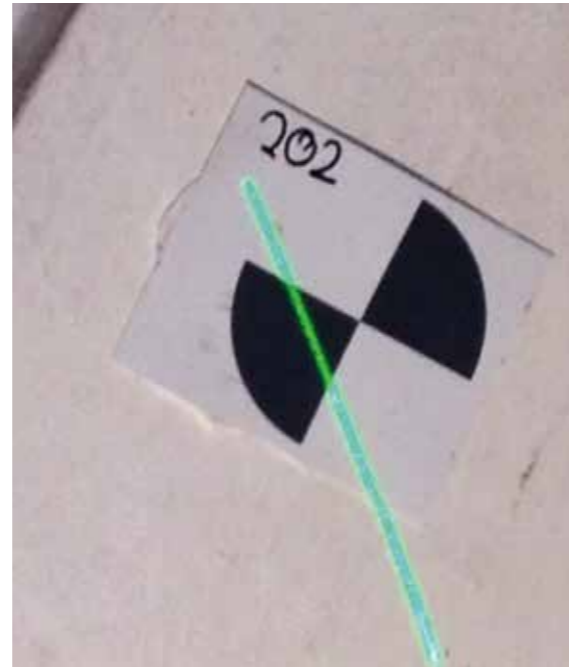

* self-adhesive

Laser Scanner Target foldable RSL496



This target can be folded flat for storage when not in use – No need to carry bulky tripods

- One sales unit of 10 pieces with a weight of 0.9 kg and with the dimensions of 220 x 130 x 95 mm fits in any rucksack.
- Ideally suited for use with scanners from Leica, GeoMax, Faro, ZF and Trimble as well as the scan function of the Leica MS50 and for the RIEGL VZ 400 from a distance of 50 m.
- Fixed points for connecting several positions
- Assignment of spatial reference information to a geospatial data set
- Can be used from two sides since it is printed on both sides (offset +2 mm)
- Suitable for inside- and outside use

RSL496 offset +2 mm with dual side use



Marking through a slot in the base plate makes repeated measurements possible.



Laser Scanner Target RSL-X80



The matching marker for the RSMP380 mini prisms

- Ideally suited for use with scanners from Leica, GeoMax, Faro, ZF and Trimble
- Also perfectly suited for Lidar and SLAM, e.g. instruments from NavVis
- Provides fixed points for linking multiple viewpoints
- Assignment of spatial reference information to a geospatial dataset
- Higher accuracy since the fixed point can be surveyed with total station in advance (e.g. with the mini prism RSMP380) – see page 72
- If need be, all markers can also be permanently glued or fixed



For repeat surveys, only the reference point (RSFP-X80) remains on the object (e.g. on a façade).



With the adapter RSA-X80g-1, the laser scanner target can exactly be fitted above the measuring point of the RS mini prism RSMP380. The height offset is 60 mm.



Laser Scanner Target RSL-X90M*



Popular for the perfect fit with the mini prisms RSMP390M*

- Ideally suited for use with scanners from Leica, GeoMax, Faro, ZF and Trimble
- Also perfectly suited for Lidar and SLAM, e.g. instruments from NavVis
- Provides fixed points for linking multiple viewpoints
- Assignment of spatial reference information to a geospatial data set
- Higher accuracy since in advance, the fixed point can be surveyed with total station (e.g. with the mini prism RSMP390M*) – see pages 74 to 77
- If need be, all markers can also be permanently glued or fixed

A product from the series "One Point Fits All" – One reference point for all instruments

For repeat measurements, only a small, barely visible, stainless steel survey mark (RSFP-X90) is left on the object as a reference point (e.g. on bridges or façades).

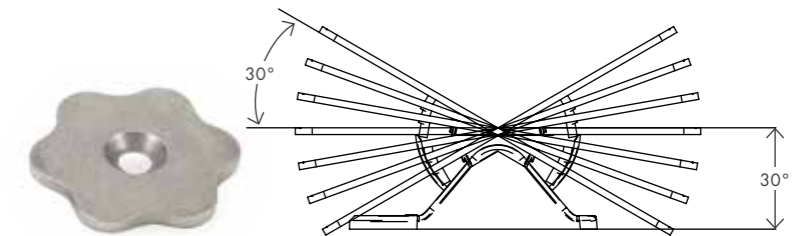

* magnetic



Laser scanner and Lidar target RSL-X93M*



Quality and precision define this target, and thanks to the special magnetic base, you can utilize the full range of our OPFA system.

Some scanners or Lidar-based instruments prefer reference points that can be located directly head-on. The RSL-X93M* target is ideal for these requirements.

Other advantages:

- Perfect for NavVis devices, as you can stop at the exact survey point, see illustration on the left
- Also ideally suited for use with Leica, Geomax, Faro and ZF (Zoller+Fröhlich) scanners
- Greater precision as the fixed point can be surveyed tachymetrically in advance, e.g. with the RSMP395M* mini prism
- Fixed points for connecting several positions
- Assignment of spatial reference information to a data set

A strong magnetic base gives the products that extra capability:

- The cavity on the magnetic base for use in conjunction with the RSFP-X90 to RSFP-X99 fixed point system makes the targets universally applicable
- We show the resulting countless number of possibilities on pages 74 to 86

A product from the series "One Point Fits All" – One reference point for all instruments

RSL-X93M*
 Tilting axis height: 100 mm

All dimensioning files are available for download from our website



* magnetic

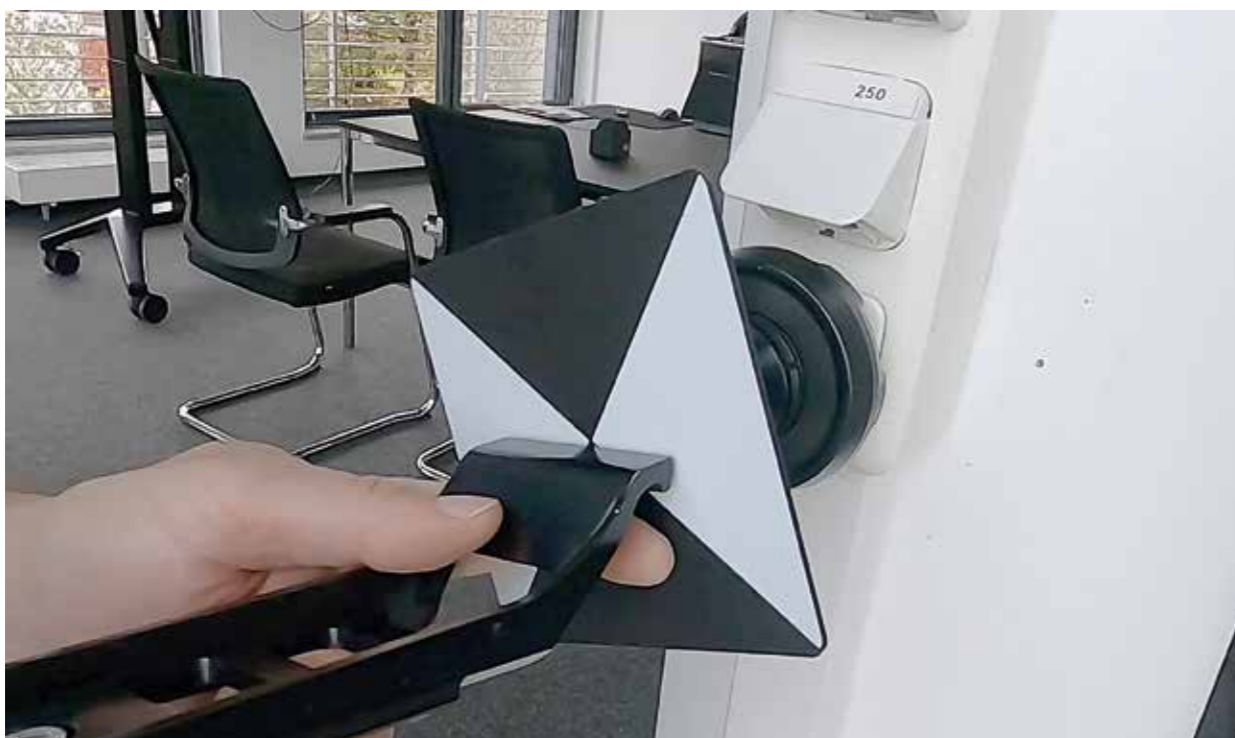

The image shows the use of the targets in combination with a NavVis instrument. Reference points for sockets RSFP-X90-30 to 36 and the suction cup RSSV-X90 are particularly very popular for indoor applications. You can find a related video on our YouTube channel.





Laser scanner target RSL422M* in a tunnel



RSL422M* on reference point RSFP-X99-12



RSL420M* on suction cup RSSV-X90



RSL422M* on floor stand RSFP-X98-1

Laser Scanner Targets with Swivel and Tilt Function RSL420M* and RSL422M*



See pages 74-77
FIXED POINT SYSTEM
RSFP-X90 to -X99

i
SUITCASE SET
KS2-420M/-2
KS2-422M/-2
Seite 92

First-class workmanship, a high level of precision and a special magnetic base make these targets something special:

- Ball bearing joints allow the laser scanner target to be aligned smoothly in any direction while always remaining precisely on axis and in position.
- The target can be used as a scanner or drone target.
- Available in two versions:
 - A) Article RSL420M* – printed on one side with offset 0 and
 - B) Article RSL422M* – printed on both sides with offset +1.5 mm
- Fixed points for linking several viewpoints
- Assignment of spatial reference information to a geodata set
- Suitable for inside and outside use

A strong magnetic base gives the products that extra capability:

- The cavity on the magnetic base for use in conjunction with the fixed point system RSFP-X90 to RSFP-X99 makes the targets universally applicable.
- We show the resulting countless number of possibilities on pages 74 to 89.

A product from the series "One Point Fits All" – One reference point for all instruments

Diameter: Ø 145 mm
Tilting axis height: 100 mm
Weight: 500 g

RSL420M*/ RSL422M* on suction cup RSSV-X90
Enables the laser scanner target to be used on any smooth surface such as glass or smooth furniture fronts with no drilling or gluing!



All dimensioning files are available for download from our website



* magnetic



Laser Scanner Spheres RSLB10M*

RSLB10SV



Laser Scanner Sphere magnetic RSLB10M* with magnetic base

Laser Scanner Sphere with suction cup RSLB10SV

- Scanning sphere made from shockproof plastic featuring special matt textured finish for optimum reflectivity
- Washable and dishwasher-safe surface
- Fixed points for linking several viewpoints
- Can be used from all sides
- Suitable for inside and outside use

A strong magnetic base gives the products that extra capability:

- The cavity on the magnetic base for use in conjunction with the fixed point system RSFP-X90 to RSFP-X99 makes the targets universally applicable.
- We show the resulting countless number of possibilities on pages 74 to 89.
 - A) Can be placed on any standard tripod or tribrach.
 - B) In combination with our floor stands RSFP-X98-2 and RSFP-X98-3: Quick, easy, and precise to handle, as well as convenient to transport.
 - C) Exact placement over an RS mini prism
- Due to the product weight, we recommend as a reference point the RSFP-X99 series with a higher magnetic adhesion.

A product from the series "One Point Fits All" – One reference point for all instruments

RSLB10M*
 Diameter: Ø 145 mm
 Tilting axis height: 100 mm (RSLB10M*)
 Weight of scanner sphere (sphere only): 250 g
 Sphericity: 0.3 mm at 20° C
 Accuracy radius: ±0.15 mm at 20° C

**Laser Scanner Sphere
on Suction Cup RSLB10SV**
 Enables the use of the laser scanner sphere on any smooth surface such as glass or smooth furniture fronts without drilling or gluing!

All dimensioning files are available for download from our website



See pages 74-77
**FIXED POINT
 SYSTEM**
 RSFP-X90 to -X99



**SUITCASE SET
 KS3-LB10M
 Seite 93**

* magnetic

Mobile Mapping-, Scanner- and Drone Targets

RSL-X94M*, RSL-X95M*, RSL-X96M*, RSL-X97M*



RSL-X94M* tilting axis height 45 mm **RSL-X95M*** tilting axis height 100 mm
RSL-X96M* (checkerboard pattern) **RSL-X97M*** (checkerboard pattern)

- **Targets made from high-quality DIBOND composite panels**
- For using from a greater distance or height
- It is also possible to measure the reference points precisely in advance with total stations, whereby accuracies of ± 1 mm can be achieved.
- In tunnels, the reference points RSFP-X90 to RSFP-X99 are first measured with the mini prism RSMP390M* or RSMP395M*. The reference points are then interchangeable with the targets RSL-X94M* or RSL-X95M*. Thus, these targets provide perfect and precise orientation for mobile mapping.
- For even more precise measurements using ground controls, the targets can be placed on a tripod directly above the centre of a prism.

This makes these targets perfect reference points for additional surveying instruments such as scanners, drones, mobile mapping, and more.

A product from the series "One Point Fits All" – One reference point for all instruments

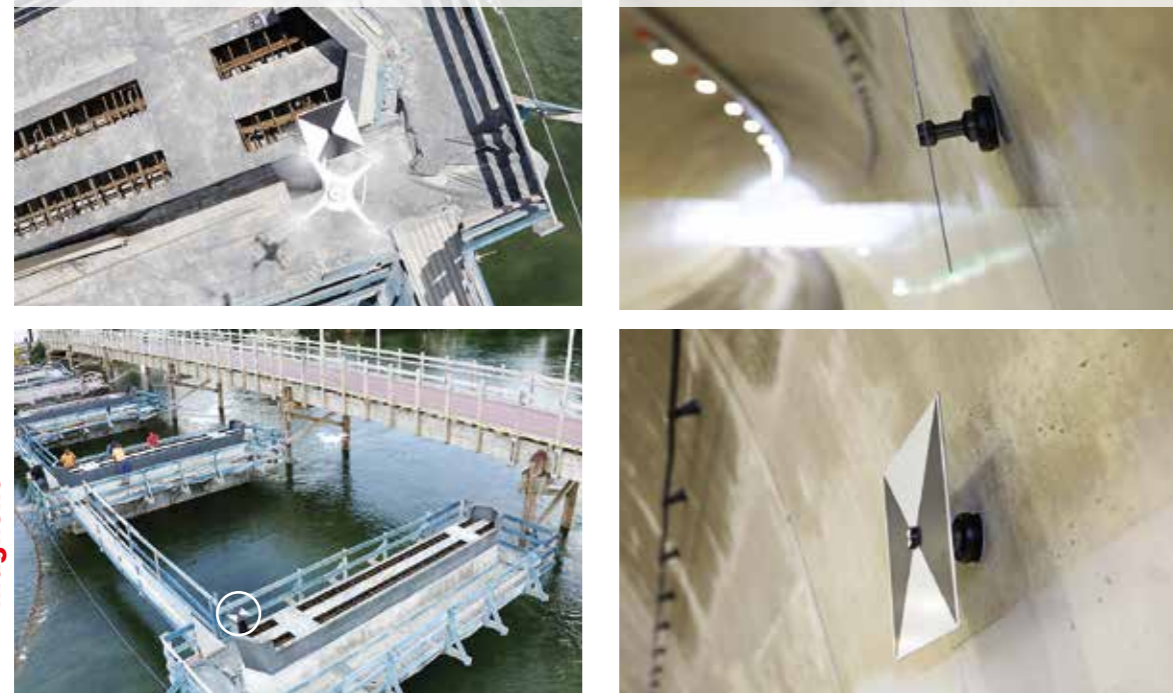

* magnetic

Laser Scanner and Drone Sign RSL 401 and RSL402

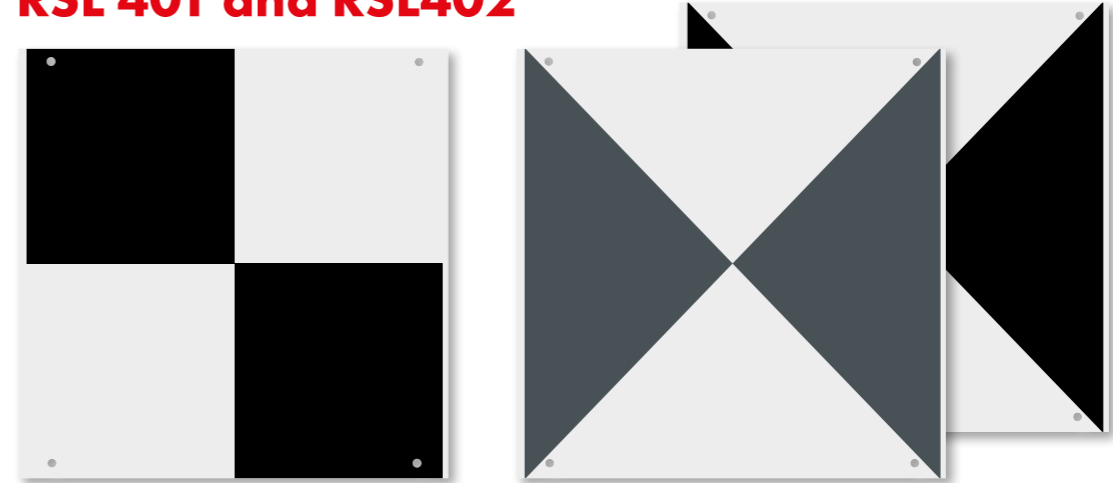

RSL401 with checkerboard pattern – printed on one side
RSL402 printed on both sides

Laser scanner sign, 400 x 400 mm, for long range scanning.

The rear face, printed in black & white, can be used as a ground marker for drones.

- **Targets made from high-quality DIBOND composite panels**
- When using mobile mapping systems, the plates can even be recognized at speeds of up to 80 km/h (50 miles/h).
- Because of their size and shape, the plates can also be used for orienteering in systems for autonomous driving.
- Can be secured to the ground with tent pegs
- Highly weather-resistant and durable thanks to premium DIBOND material.





Scanner target RSL602M* on a concrete column: No drilling is required thanks to the RSFP-X99-70 strap solution.



RSL632M* at ground target RSFP-X97-2



RSL652M* at ground target RSFP-X97-3

Laser scanner, Lidar and SLAM targets RSL602M*, RSL672M* RSL632M* and RSL652M*

See pages 74-77

**FIXED POINT
SYSTEM**

RSFP-X90 to -X99



with swivel and tilt function, magnetic

Thanks to ball-bearing joints, the targets can be effortlessly aligned in any direction while remaining precisely on-axis and in position.

The targets are suitable for use as scanner, Lidar, SLAM and drone targets and are available in **different versions:**

- A) Article RSL602M* – with 200 x 200 mm target, tilting axis height 150 mm
- B) Article RSL672M* – with 300 x 300 mm target, tilting axis height 200 mm
- C) Article RSL632M* – with 200 x 200 mm target, tilting axis height 150 mm
- D) Article RSL652M* – with Ø 300 mm target, tilting axis height 200 mm
- E) Artikel RSL682M* – with 400 x 400 mm target, tilting axis height 250 mm

Features and applications:

- Can be placed on any standard tripod or tribrach.
- In combination with our floor stands RSFP-X98-2 and RSFP-X98-3: Quick, easy, and precise to handle, as well as convenient to transport.
- Provides the option for precise placement over RS Mini Prisms RSMP380.
- Fixed points for connecting several positions
- Precise assignment of spatial reference information to a geodata set, even over larger distances.

For mounting on tripods or tribrachs we offer the adapters RSFP-X90-1 and RSFP-X99-1.

We recommend the RSFP-X99 fixed point with enhanced magnetic force for mounting on walls or non-metallic surfaces due to the dead weight.

A product from the series "One Point Fits All" – One reference point for all instruments

* magnetic





SLAM Target RSL430 on floor stand RSFP-X98-1

SLAM Target RSL452M* on suction cup RSSV-X90.
Can also be used for RIEGL scanners.

Laser Scanner and SLAM Targets RSL430, RSL452M* and RSL453M*

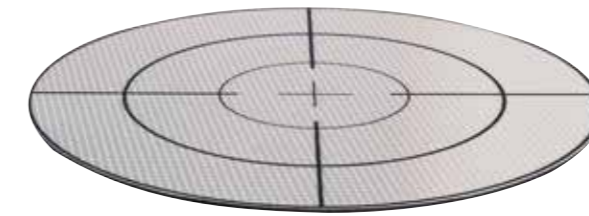

RSL430

- Automatically recognized through shape and reflection when using compatible software.
- Frequently used as a ground target.



RSL452M* and RSL453M* rotatable and tiltable with magnetic base

- Ball-bearing joints allow the target to be easily aligned in any direction while always remaining precisely centred and in position.
- The target can be used as a scanner and drone target.
- The RSL453M* target has two differently-sized reflective targets, the centres of which are exactly opposite one another. One side is 50 mm in diameter and the opposite side is 145 mm in diameter. This means, for example, with a RIEGL scanner you can tilt the target and use the same reference point for different distances.
- Fixed points for connecting several positions
- Assignment of spatial reference information to a geodata set
- Suitable for indoor and outdoor use

A strong magnetic base gives the products that extra capability:

- The cavity on the magnetic base for use in conjunction with the fixed point system RSFP-X90 to RSFP-X99 makes the targets universally applicable.
- We show the resulting countless number of possibilities on pages 74 to 89.
- One example of the many possibilities: When used inside, our socket adapters and suction cups allow you to create permanent reference points without leaving any marks!

A product from the series "One Point Fits All" – One reference point for all instruments



SUITCASE SET
KS2-452M/-2
KS2-453M/-2
Page 92

* magnetic



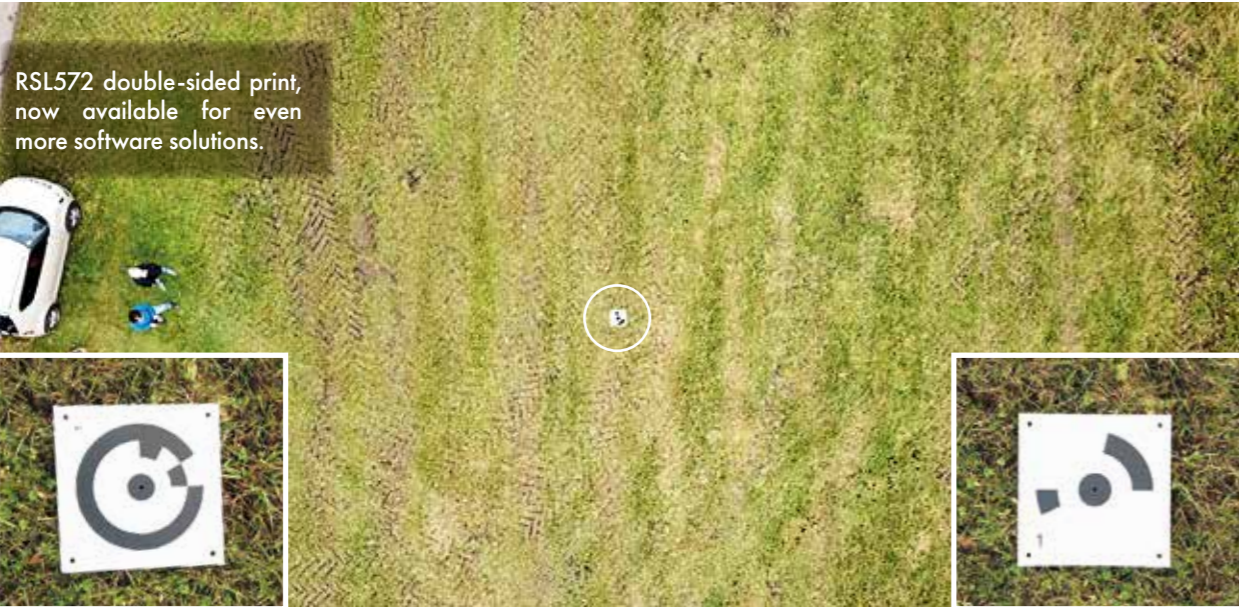

RSL572 double-sided print, now available for even more software solutions.



RSL532 in use on both sides for maximum contrast on different surfaces



NOTE: the recognition of these markers from heights above 40 meters is only possible with good equipment!

Ground Control Targets for Drones

- with cross RSL512

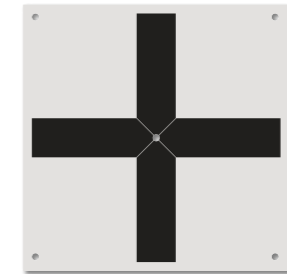
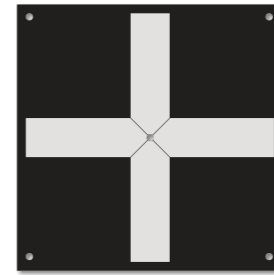

RSL512 printed on both sides for maximum contrast on different surfaces

- with circle RSL520 and RSL532

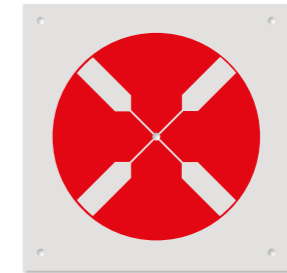
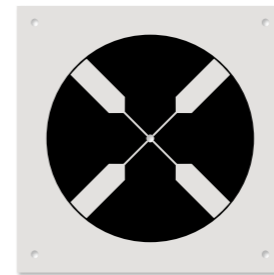
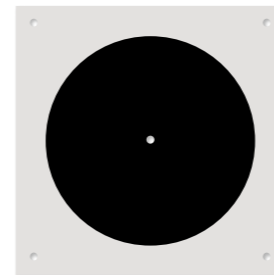

RSL532 printed on both sides for maximum contrast on different surfaces. Ideal for use up to a height of approx. 100 meters, for heights above 100 meters, we recommend the hinged ground markers (see next page)

- with numbering RSL572-10, RSL572-20 and RSL572-30



NEW

printed on both sides: Numbering 1 - 10

Numbering 11 - 20

Numbering 21 - 30

- Size 350 x 350 mm
- Waterproofed and UV resistant
- A central hole permits exact calibration by GPS
- Can be secured to the ground with tent pegs
- Can be used lots of times

- **Marker visibility is device and weather-dependent**
- Automatic number recognition with appropriate software such as: Agisoft (RSL572-10, RSL572-20, RSL572-30)





Drone target RSL512XL



Drone target RSL532XL

Ground Control Targets for Drones, unfoldable

- RSL512XL, unfoldable with cross

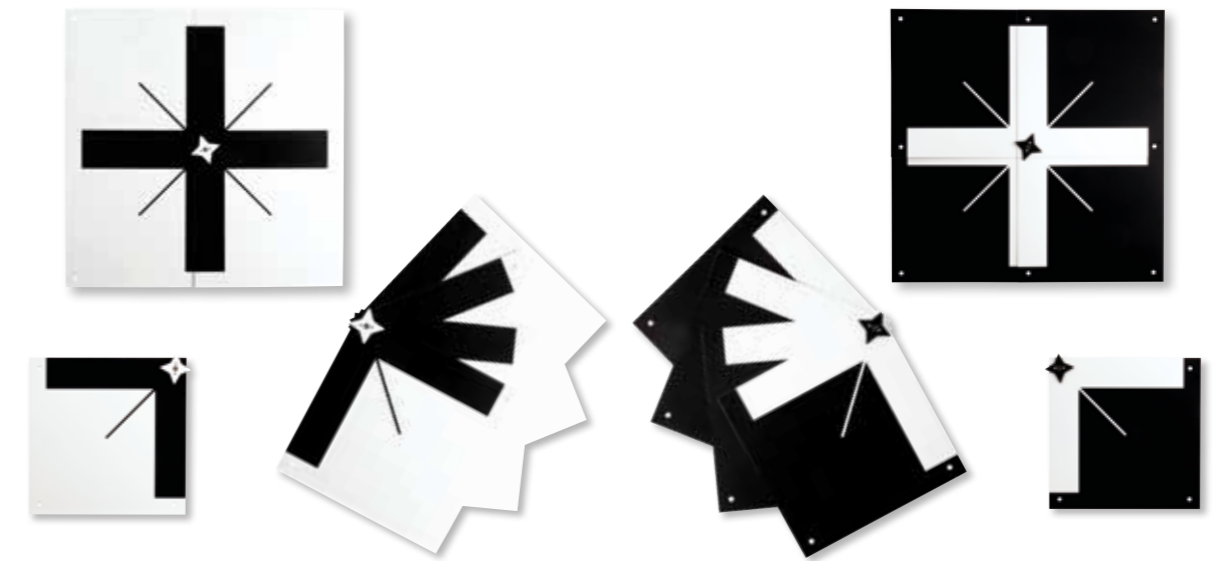

- RSL532XL, unfoldable with circle

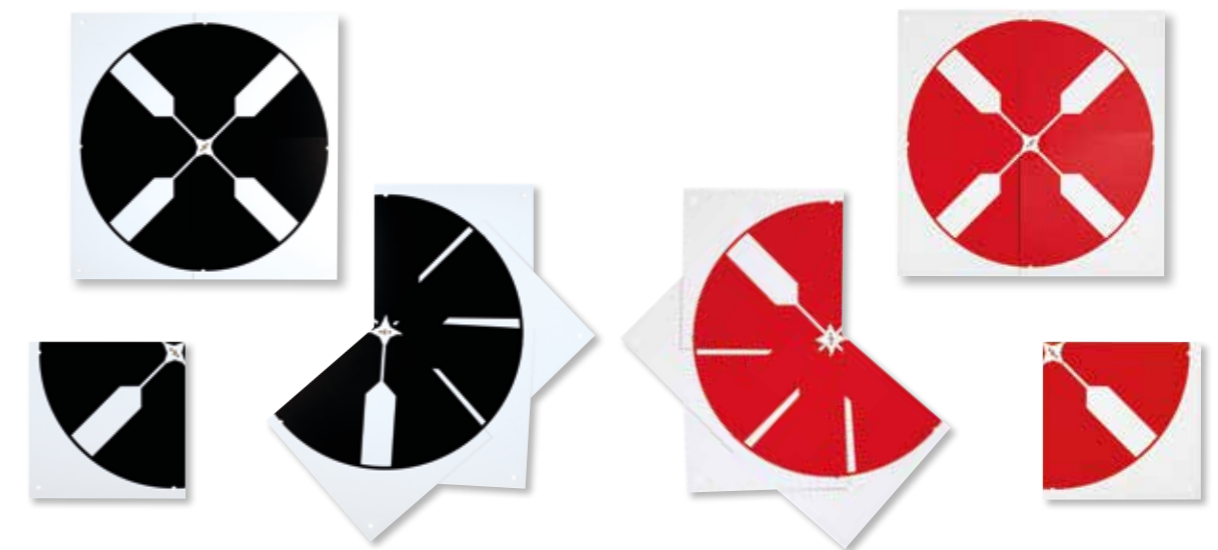

- Size 350 x 350 mm closed, 650 x 650 mm opened
- Waterproofed and UV resistant
- Fixed points for use with drones
- A central hole permits exact calibration by GPS
- Can be secured to the ground with tent pegs

- Can be used lots of times
- Ideal for heights above 100 meters
- **Marker visibility is device and weather-dependent**
- Printed on both sides, depending on the background, the lighter or darker side can be used



Drone Targets RSL580-10 and RSL580-20



Still higher accuracy when using scanners and drones

Combined with the fixed point RSFP-X80, the reference points can first be surveyed exactly with our mini prisms (e.g. RSMP380). The drone markers RSL580 can then be clipped into the same fixed point for the use of drones (see page 72). With adequate quality of the cameras or surveying instruments, accuracies of ± 1 mm can be achieved.

In combination with the adapter RSA-X80g-1, the RSL580 drone markers can be placed exactly above the surveying point of the mini prism. With the adapter RSA-5/8-1, this combination can be mounted on any current tribrach or tripod with 5/8" UNC thread.

See illustrations below.

With high-quality cameras, accuracies of ± 1 mm have already been achieved from an altitude of 35 meters!



Drone Targets RSL590M-10* and RSL590M-20*



Highly precise and flexible thanks to the OPFA system

Combined with the fixed point system RSFP-X90, the reference points can first be exactly surveyed with our mini prisms (e.g. RSMP390M*).

The drone markers RSL590M* can then be placed on the reference points for the use of drones (see pages 74-77).

Very exact assignment of spatial reference information to a geospatial data set is thereby achieved. Accuracy ± 1 mm.

For repeat measurements, only a small, barely visible, stainless steel survey mark (RSFP-X90) is left on the object as a reference point (e.g. on bridges or buildings).

A product from the series "One Point Fits All" – One reference point for all instruments



* magnetic





4/4 Boundary Markers RSKM10 to RSKM40

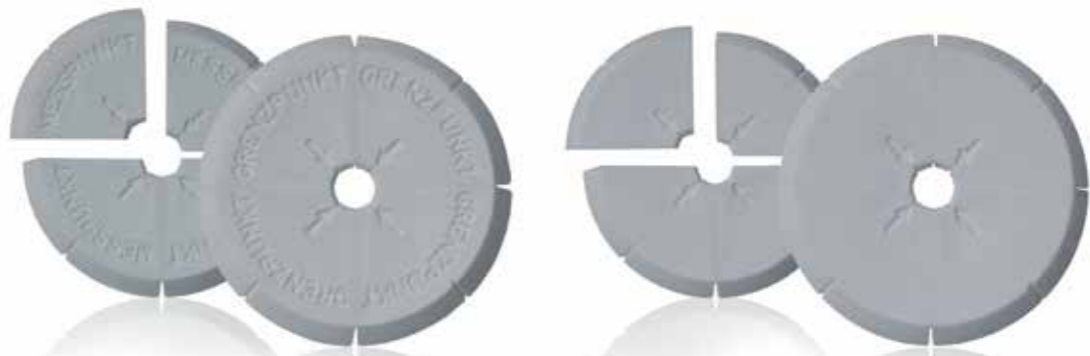

More precision at corners and edges

The boundary markers are used on solid surfaces as boundary or survey points.

Thanks to an indentation on the back, they can be divided into up to four pieces, allowing for precise documentation of boundary or survey points at interior corners, along walls or masonry, and at exterior corners.

Our RSMK-FIX glue is ideal for affixing markers.

The following products are available:

- RSKM10: 4/4 Boundary Markers without inscription
- RSKM20: 4/4 Boundary Markers with inscription "GRENZPUNKT"
- RSKM30: 4/4 Boundary Markers with inscription "MESSPUNKT"
- RSKM40: 4/4 Boundary Markers with inscription "SURVEY MARK"

RSKM10 to RSKM40

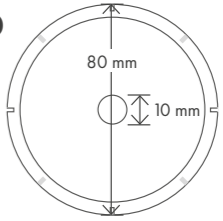

Fixed Point RSFP1 and Protection Cap RSFP1-A



When used as a fixed point on the ground, this point can be surveyed with a prism so it can be checked quickly and easily if necessary, for example if it is suspected that the fixed point has been moved due to outside interference.



The aluminum plate RSFP1 is fitted with a 5/8" UNC stainless steel male thread for screwing on a prism or a measuring instrument. If the plate is used as a fixed point on the ground, the surveyor can position his instrument on his tripod precisely above the cross.

The fixed point RSFP1 is supplied with a plastic protection cap for the 5/8" UNC thread. An aluminum protection cap RSFP1-A with 5/8" female thread is also available.

All dimensioning files are available for download from our website



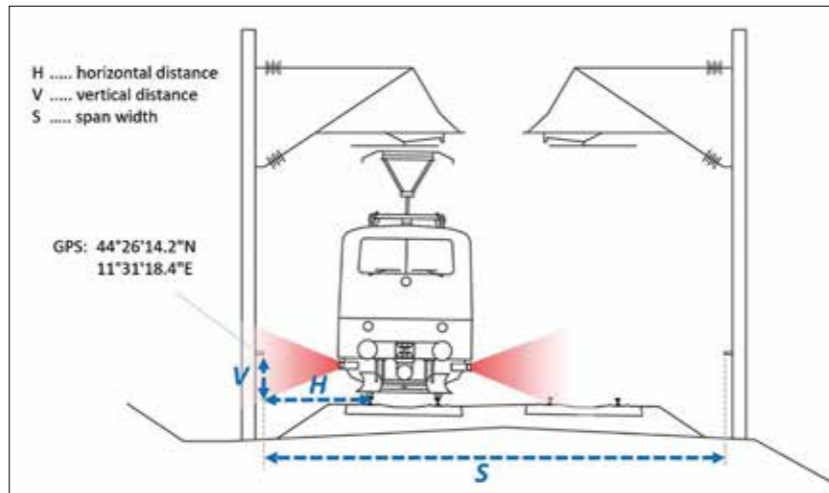

The measurement values of the RPM system

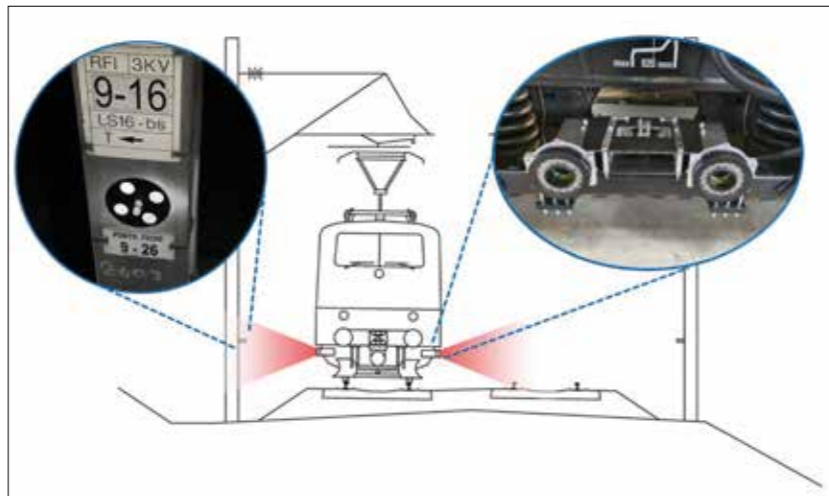

The measuring target mounted on a side post (left) and the RPM stereo-camera system (right)



The RPM system installed on the 08-275 Unimat Combi (RFI Italia) tamping machine

Track Machine Targets

TMT10

TMT20, TMT25

TMT30



Special targets to surveying the absolute track geometry with the RPM stereo camera system

The Reference Point Measurement (RPM) system is a high speed measuring system for track geometry. The resulting track geometry is the fundamental data basis for the tamping machine to maintain perfect track position.

Reference points with known coordinates are used to determine the absolute position of the rail track at speeds up to 100 km/h. A stereo-camera measures the distance between the wheel flange point of the rail and the reference point with a ± 2 mm accuracy. Combined with the relative track geometry of the inertial measurement system the result is a high precision 3D trajectory in geo-coordinates.

The RPM system uses two stereo-cameras mounted on each side of the vehicle for measuring the distance between the wheel flange point and the reference point. Dedicated flashlights ensure reliable operation at day and night time. The dedicated measuring target is installed on either existing reference points (metallic bolts) or a new reference geometry is established with an initial measuring run.

Accessory for TMT10 round marker



Starlock disc (11 mm / 12 mm)



Assembly aid for starlock disc



All dimensioning files are available for download from our website

Laser Target, foldable RSLT10

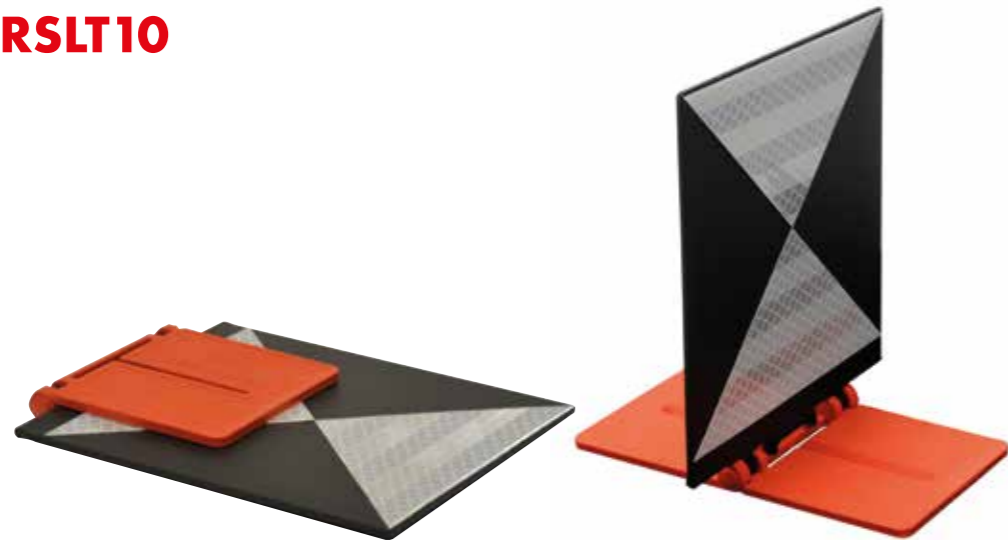

Aline line laser quickly and accurately

The laser target RSLT10 was developed for the fast and exact alignment of a line laser on axis. The laser target can be folded down and can therefore be stored in the laser box or stowed away in another space saving place.

Place the laser target on the axis on which you want to align the laser. Turn the laser with active axis line in the area of the laser target to left and right until you see the laser line on the laser target and align the laser on the center of the target.

Please note: For alignment, your head must be at the same height as and next to or behind the laser. Only then can the reflection of the laser line from the target be clearly seen and, even in bright sunlight, be used at a range of up to 30 m.



RSA-K480, RSA-K625 and RSA-K515-665 Coupler Adapter



Fast and precise measurement of couplings and similar components

In bridge building and on large projects, parts of the reinforcement often have to be connected with a coupler joint. To ensure that the reinforcement is placed in exactly the right position, the couplers must be checked for their exact position before concreting work.

On large projects with numerous couplers, this is a very time-consuming task for the surveyor. The measurements become even more complicated if the couplers do not protrude vertically from the floor, but rather laterally or at an angle from the wall.

With our adapters, these measurements can now be carried out quickly and precisely:

- For couplers that need to be measured laterally, two prisms are mounted on the adapters. First, the outer prism (gray in picture below center) is measured, followed by the second prism (red in picture), determining the direction to the coupler head (as in measuring by dual-prism offset). The centre of the coupler head is then determined by the specified height offset from prism two to the coupler head.
- When measuring vertical connections, one prism is sufficient, but in this case, we recommend our 220 degree prism RSMP480 so as not to lose contact with the station when turning the adapter.



ONE FIXED POINT FOR ALL INSTRUMENTS

RSFP-X80

Fixed Point System RSFP-X80, Suction Cup RSSV-X80 and Magnet Pot



For all instruments the same reference point!

The RSFP-X80 fixed points are ideal for monitoring. Prisms can be attached quickly and easily, for example, to façades and bridges – without the need for drilling.

Magnetic versions are available for steel and marine construction as well as all magnetic surfaces. Creating precise reference points has never been easier.

The system also offers a suitable suction cup for glass and smooth surfaces.



Products from our system One fixed point for all instruments Fixed Point System X80

ONE FIXED POINT FOR ALL INSTRUMENTS

RSFP-X80

RSFP-X80 fixed point

Suitable for all products from the X80 series: RS183, RSMP380, RSMP480, RSL-X80 and RSL580.

The fixed point can be attached to all standard surfaces using the recommended RSMK-FIX mounting adhesive. Especially popular for track monitoring: Once the work has been completed, the prism can be easily removed from the plate, leaving only the cost-effective RSFP-X80 fixed point behind.

RSMS1033 magnet pot for X80 targets and prisms

The X80 series with pot magnet RSMS1033 is ideal for surveying in steel construction, on ships or for calibrating excavator controls. The magnet is placed over the survey point by means of a cavity in the center. Then the target or prism is simply placed on the pot magnet and aligned with the measuring instrument – and you're done! A fixed point can also be created very quickly.

The RS183M target and the RSMP380M and RSMP480M prisms are supplied with the RSMS1062 magnet and are specially designed for monitoring tracks and steel structures. There is no quicker way of mounting on steel – no need to glue, clean or dry the surface.

In the RSMS-X80 pot magnet set, the magnet itself serves as a reference point; prisms and targets can simply be attached and rotated in all directions.

RSSV-X80 suction cup

Version Ø75 mm for RS183, RSMP380, RSMP480, RSL-X80 and RSL580

For all glass and smooth surfaces, inside and outside. Its pump function allows the suction cup to be firmly attached to the surface.

Simple and quick installation – with no gluing or drilling required – is so guaranteed.



*Replacement magnets (RSM1030 and RSMS1062) are available as accessories.



ONE FIXED POINT FOR ALL INSTRUMENTS
RSFP-X90 to -X99

Fixed Point System RSFP-X90 to RSFP-X99

for all RS products with magnetic base

One reference point for all instruments:

ROTHBUCHER
ONE POINT
FITS ALL SYSTEM



Exceptional solutions make this system to a highlight in the survey field

- The fixed point system RSFP-X90 to RSFP-X99 is made of special stainless steel which reacts to magnets
- Magnets in the base plate securely hold various RS products precisely on the same point.
- For repeat surveys, the resumption point RSFP-X90 is much appreciated, as it is almost invisible to passers-by, e.g. on bridges or façades.
- On building sites, the resumption point RSFP-X90 is used as a reference point
- Perfect for BIM, for surveys with scanners Scanner, Lidar or SLAM
- See the following pages for many more application examples
- Depending on the instruments, accuracies of ± 1 mm are possible

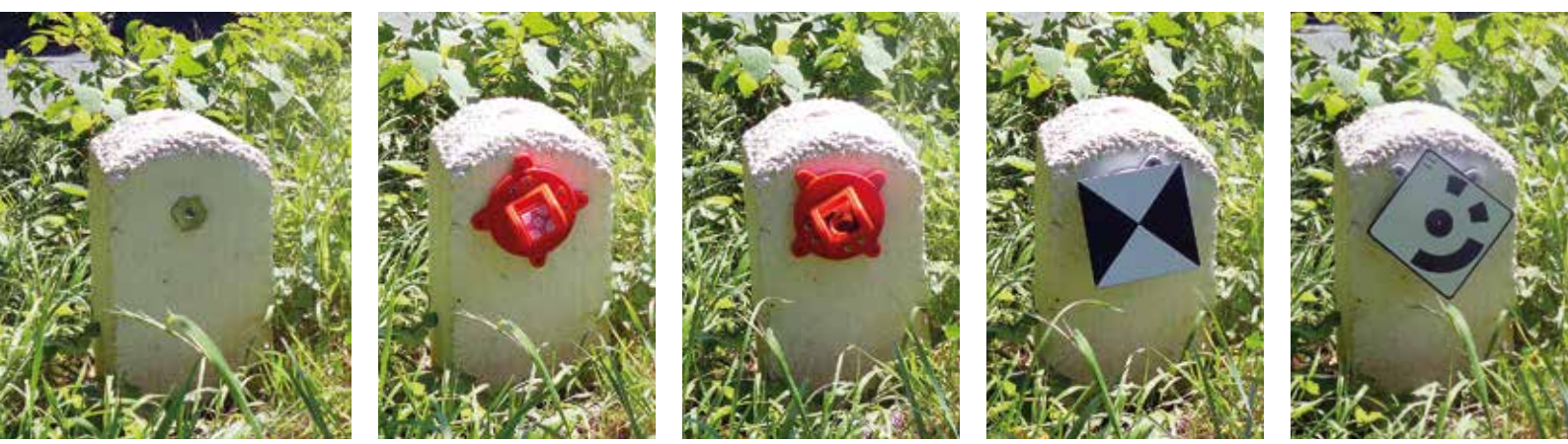

Fixed Point System RSFP-X90

Create fixed points quickly, easily and permanently



Using the correct offset, the surveyor always obtains the same survey point and the same XYZ coordinates.

Fixed Point System RSFP-X99

For challenging surfaces and enhanced magnetic adhesion to the adapter



Available tilting axis heights:

45 mm, 100 mm, 150 mm and 200 mm

Products with tilting axis height 45 mm



Products with tilting axis height 100 mm



Products with tilting axis height 150 mm



Products with tilting axis height 150 mm



Products with tilting axis height 200 mm



Products for the fixed point system RSFP-X90 to RSFP-X99





ROTHBUCHER
ONE POINT
 FITS ALL SYSTEM

ONE FIXED POINT FOR ALL INSTRUMENTS
 RSFP-X90 to -X99

RSFP-X90 fixed point – the most well-known fixed point from this series – for gluing or screwing

Fixed Point for all RS products with magnetic base. When using products with the same tilting axis height the reference point always remains exactly the same!



RSFP-X90-1, RSFP-X90-3 adapter

RSFP-X90 fixed point as separate version with a 5/8" (RSFP-X90-1) or 3/8" (RSFP-X90-3) female thread, when used with a tripod with 5/8" or 3/8" UNC threaded rod.



RSFP-X90-2 adapter

RSFP-X90 fixed point as separate version with a 5/8" male thread, when used with a tripod with 5/8" UNC threaded rod or in combination with the RSA-5/8-1 adapter.



RSFP-X90-m6, RSFP-X90-m8 adapter

The fixed point RSFP-X90 is also available as a separate version with a m6 thread (RSFP-X90-m6) and a m8 thread (RSFP-X90-m8).



ONE FIXED
POINT FOR ALL
INSTRUMENTS

RSFP-X90 to -X99

ROTHBUCHER ONE POINT FITS ALL SYSTEM

RSFP-X90-30 to 39* adapter

Power socket adapter – smart solution for reference points inside

* available in different country versions

Digital 3D surveys are standard nowadays, and often one of the challenges is installing reference points in occupied areas so they are not visible.

We have developed these products precisely for this purpose.

In keeping with our “One reference point for all instruments” system, you can now use any socket as a reference point for all instruments. Take a picture of the socket used and you can recreate exactly the same survey point even after a long period of time without leaving a trace.

Suitable for this system and for the 3D survey, our suction cup and floor stand.



RSFP-X90-5 adapter

In combination with Leica bolts there is the RSFP-X90-5 adapter, enabling all our products with a magnetic base to be easily attached to any Leica bolt.

RSFP-X99-5 adapter

In combination with Leica bolts there is also the RSFP-X99-5 adapter. If greater magnetic adhesion to the adapter is desired or required, we recommend this version (e.g. in tunnels).

ROTHBUCHER ONE POINT FITS ALL SYSTEM

ONE FIXED
POINT FOR ALL
INSTRUMENTS

RSFP-X90 to -X99

RSFP-X90-20, RSFP-X90-21 adapter

Fixed point RSFP-X90-20 and RSFP-X90-21 with heavy duty anchor.

For quick and safe mounting of reference points on rocks, difficult surfaces or on historic buildings in the mortar joint.

Lengths 70 mm (RSFP-X90-20), 105 mm (RSFP-X90-21)
Borehole of \varnothing 10 mm)

RSFP-X99-20, RSFP-X99-21 adapter

Fixed point RSFP-X99-20 and RSFP-X99-21 with heavy duty anchor.

If stronger magnetic adhesion to the adapter is desired or required, we recommend this version. It is also often preferred for challenging surfaces, such as sprayed concrete.

Lengths 70 mm (RSFP-X99-20), 105 mm (RSFP-X99-21)
Borehole of \varnothing 10 mm)

RSFP-X90-25, RSFP-X90-26 adapter

RSFP-X90 fixed point for clamping points or pipes with \varnothing 22-24 mm (RSFP-X90-25) and \varnothing 27-29 mm (RSFP-X90-26). Reusable

It has never been easier to create fixed points on construction site.

RSFP-X99-25, RSFP-X99-26 adapter

RSFP-X99 fixed point for clamping points or pipes with \varnothing 22-24 mm (RSFP-X99-25) and \varnothing 27-29 mm (RSFP-X99-26). Reusable

If greater magnetic adhesion to the adapter is desired or required, we recommend this version.



ONE FIXED
POINT FOR ALL
INSTRUMENTS

RSFP-X90 to -X99

ROTHBUCHER ONE POINT FITS ALL SYSTEM

RSSV-X90 suction cup

Version Ø 120 mm for all RS products with magnetic base

For all glass surfaces and smooth surfaces, inside and outside.

Its pump function allows the suction cup to be firmly attached to the surface. Simple and quick installation – with no gluing or drilling required – is so guaranteed.

The perfect accessory for the 3D survey: suction cup RSSV-X90, power socket adapter RSFP-X90-30 and floor stand RSFP-X98-1 and RSFP-X98-2.



RSSV-X99 suction cup

If greater magnetic adhesion to the adapter is desired or required, we recommend this version.

RSFP-X97-2/-3 ground marker spike

RSFP-X97-2: Aluminium ground marker spike, 270 mm long

RSFP-X97-3: Steel ground marker spike, 470 mm long

These ground targets are always driven into the ground when there is no means of creating a reference point on objects. This means that permanent reference points can be created even on open grassland, sandy soils and other suitable surfaces and used with a wide variety of instruments.

Examples of use:

- 1) Fix the ground marker spike in the soil.
- 2) Screw the GNSS antenna onto the RS0195M adapter and place it on the ground marker.
- 3) After a short time, the reference points can be used with total stations, scanners, Lidar, or drones.

For use with an GNSS antenna pole, we offer the fixed points RS090M and RS0190M.



ROTHBUCHER ONE POINT FITS ALL SYSTEM

ONE FIXED
POINT FOR ALL
INSTRUMENTS

RSFP-X90 to -X99

RSFP-X97-1+2 floor stands

The **RSFP-X98-1 floor stand** is frequently used for quickly relocating total stations or scanners. Another practical application is use as a temporary solution for reference points – simply unfold, set up, attach the target or prism and you're done!

A space-saving and versatile accessory that achieves an accuracy of around 1.0 mm to 1.5 mm when handled carefully!



The **RSFP-X98-2 floor stand** offers additional application options:

- Can be placed exactly over an existing reference point
- Can be precisely aligned using a spirit level and screws
- Also suitable for staking
- Can optionally be supplied with a 5/8" connector and is therefore also suitable for GNSS and GPS antennas and other accessories with this connector.

A space-saving and versatile accessory that even exceeds the accuracy of the RSFP-X98-1 floor stand when handled carefully.



ONE FIXED POINT FOR ALL INSTRUMENTS

RSFP-X90 to -X99

ROTHBUCHER ONE POINT FITS ALL SYSTEM

RSFP-X99 fixed point

For quick fixing on difficult substrates using adhesive, there is the RSFP-X99 support plate. In addition, the stainless steel support plate for magnets provides significantly more adhesion for all our products with a corresponding base plate.

As a long-term solution for monitoring on steel structures, these parts can also be welded on.



RSFP-X99M fixed point

The RSFP-X99M fixed point is the quickest and easiest way to create a reference point on any magnetic surface. With this version, there is no need to glue, clean or dry the surface to create a reference point. The fixed point is simply placed in the desired location – and is ready to use!

As part of the OPFA system, the fixed point can be used with all standard measuring instruments. Thanks to the strong magnetic force, this version is also ideal for monitoring steel structures.

RSFP-X99-1 fixed point

For tripod or tribrach

The RSFP-X99-1 fixed point has two large plates made of stainless steel suitable for magnets and a 5/8" internal thread, which means it can be mounted on all tripods or tribrachs.

Thanks to the enhanced magnetic force, even large scanner targets can be used outdoors. Even at higher wind speeds, the target remains reliably attached to the fixed point.

ROTHBUCHER ONE POINT FITS ALL SYSTEM

ONE FIXED POINT FOR ALL INSTRUMENTS

RSFP-X90 to -X99

RSFP-X99-11+12 fixed point

On construction sites and in tunnels where anchor sleeves with DW15 threads are commonly used, the RSFP-X99-11 adapter allows the use of existing anchor sleeves as permanent reference points for surveying and monitoring.

Without the need for drilling, this solution enables the creation of reference points for total stations, scanners, drones, SLAM, or mobile mapping that are unparalleled in durability. Even if the adapter is damaged, the anchor sleeve remains securely embedded in the concrete, ensuring that the original survey point can always be restored.

For long-term reference points on very difficult surfaces, we recommend the RSFP-X99-12 fixed point with a rod length of 160 mm.



RSFP-X99-70 fixed point for tension belt

The RSFP-X99-70 fixed point can be used with all types of tension belts up to 32 mm.

The RSFP-X99-70 is supplied without a tension belt.

Applications:

- On columns where drilling is not desirable
- On trees, ideally close to the roots
- On historic columns where drilling is generally not desirable



RSFP-X99-73 fixed point

For quick and precise reference points on pipes and scaffolding with \varnothing 48-51 mm. With the RSFP-X99 fixed point, prisms and all scanner, Lidar, SLAM and drone targets can be attached quickly. The large plate provides stability, even for larger targets.

Particularly useful for scaffolding that prevents scan transition from inside to outside: Reference points on the scaffolding provide a simple and precise link. Also suitable for railings with the right diameter.



ROTHBUCHER ONE POINT FITS ALL SYSTEM

Adapter-Set RSFP-X90-S40

The adapters can be easily attached to one of the magnetic bases (e.g. RSMP390M). The parts are automatically positioned correctly by the RSFP-X90 reference point (flower) and held by the magnets on the base plate.

Depending on the attachment, the user has now the following possibilities:

- Control measurements of inside and outside corners
- Control measurements at recesses or at the edge of the ceiling
- Measurements on pillars – direct measurements can be taken on bevelled edges at the vertex!
- Transfer heights around the corner with marking attachment
- Measure of position and heights of corner blocks quickly and precisely when bonding clay blocks



RSPC90M cover

The RSPC90M protection cap protects the RSFP-X90 series reference points from soiling and weather effects such as ice and snow. Thanks to the magnetic lid, the protection cap can be removed from or placed on the reference point with a flick of the wrist.

For using reference points on the ground, the protection caps have a cross printed on them, so surveyors can easily position themselves over a reference point.

When using the RSFP-X90 reference points on walls and façades, the cross on the protection cap is used as reference points for SLAM and Lidar. Caution: you need to plan for an offset here!

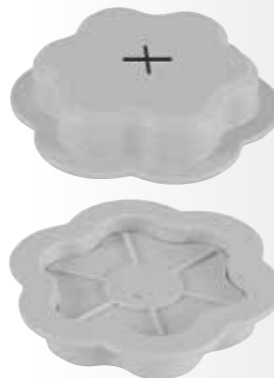

Accessories

Adapters RSA-X80g-1 and RSA-X80g-2

A plug system is built into the base plate of many of our products as standard, enabling a wide variety of connections between the products.

The RSA-X80g-1 angled adapter and the RSA-X80g-2 adapter enable other combinations that are very helpful for surveying, such as:

- RS mini prisms stacked on top of each other for measurements from bottom to top, e.g. from level 0 to level XY
- RS mini prisms with RS scanner targets
- RS mini prisms with RS ground control targets
- RS mini prisms with RS SLAM targets
- RS mini prisms with RS mobile mapping targets

**The RS surveying accessory system:
High precision with countless options.**

Adapter with 5/8" thread RSA-5/8-1

With the adapter RSA-5/8-1, many further combinations can also be easily mounted on a tribrach.

See figure below right.

When mounting the scanner targets RSL420M and RSL422M over a prism, the adapter RSA-5/8-1 is additionally used as a connecting piece.

In Combination

Thanks to our extensive RS surveying accessory system, different surveying instruments can use the same reference point or measurements can be made using various surveying instruments with exactly the same survey point.

The illustration on the right shows one of the various combinations that are possible thanks to the clever plug-in system and the ever growing range of accessories available at Rothbucher Systems.

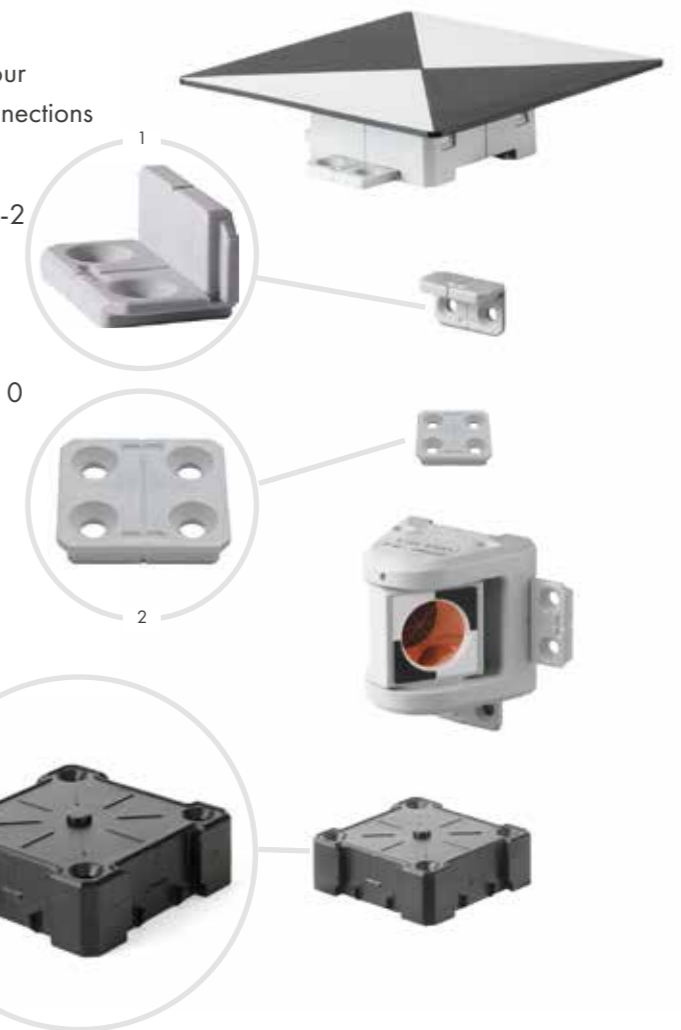

Accessories



Protection Cap RSPC20 and RSPC20M*

These protection caps protect prisms and reflective targets from the weather and soiling. For points that are hard to reach, on a tunnel roof, for example, we offer the magnetic version.

The metal cube RSPC50 can be screwed onto a prism pole with 5/8" thread (see illustration below). This enables the protection cap to be removed from and fitted over the prism at a height of 3 - 4 meters.

RSPC20/RSPC20M* for RS183,
RSMP280, RSMP380, RSMP480



*magnetic

Metal Cube RSPC50 with 5/8" Female Thread

With its 5/8" thread, the metal cube RSPC50 can be screwed onto a prism pole.

The magnetic protection cap RSPC20M* can thereby be easily fitted over and removed from the plastic case of the prisms, even from difficult positions, and refitted at any time.



Construction Glue with high grab RSMK-FIX

- High-performance mounting adhesive with instant initial adhesion
- Isocyanate- and silicone-free
- Permanently elastic and suitable for a wide range of uses
- Odourless
- RSMK-FIX is suitable for all products from Rothbucher Systems
- Can be used in any current pistol applicator
- A good applicator is recommended



Suitcase Sets with Reflective Targets

Ideal for construction surveying, staking out and measuring



Fig. KS1-193M+
Metrics: W 390 mm x H 310 mm x D 200 mm
Weight: 6.3 kg

Compactly and safely packaged, practical and quickly to hand – our suitcase sets, the ideal companion: Everywhere.

Suitcase KS1-193M+ with:

- 4 Reflective Targets RS192M or RS193M
- 1 Stake Out Aid RS96

Accessories

- 2 Suction Cups RSSV-X90
- 2 Adapters RSFP-X90-1
- 2 Adapters RSFP-X90-2
- 30 Fixed Points RSFP-X90
- 4 Fixed Points RSFP-X90-20
- 2 Fixed Points RSFP-X90-21
- 2 Fixed Points RSFP-X90-25
- 2 Fixed Points RSFP-X90-26
- 4 Fixed Points RSFP-X99-11



Reflective Target
RS193rM



RS96

Suitcase KS1-193M+-2:

Contents like KS1-193M+ with additional trays for further surveying accessories.

Options as shown in the following illustration:

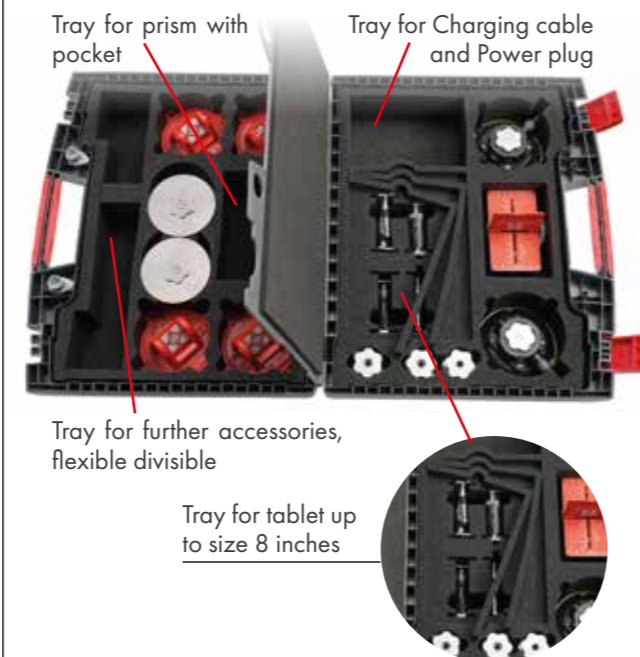

Fig. KS1-193M+-2
Metrics: W 500 mm x H 420 mm x D 225 mm
Weight (without tablet an additional accessories): 7.8 kg

Suitcase Sets with Prisms

Ideal for construction surveying, staking out and measurements with robotic total stations



Fig. KS1-390M+
Metrics: W 390 mm x H 310 mm x D 200 mm
Weight: 6.3 kg

Our suitcase sets are also available with additional compartments for more room to store additional accessories – see illustration.

Suitcase KS1-390M+C/S with:

- 4 Mini Prisms RSMP390M
- **optional** 1 Stake Out Aid for Robotic Total Stations RS150M

Accessories

- 2 Suction Cups RSSV-X90
- 2 Adapters RSFP-X90-1
- 2 Adapters RSFP-X90-2
- 30 Fixed Points RSFP-X90
- 4 Fixed Points RSFP-X90-20
- 2 Fixed Points RSFP-X90-21
- 2 Fixed Points RSFP-X90-25
- 2 Fixed Points RSFP-X90-26
- 4 Fixed Points RSFP-X99-11



Mini Prism
RSMP390rM-S

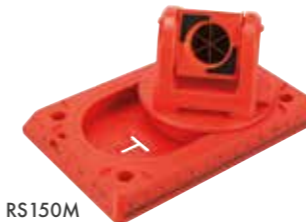

RS150M

Suitcase KS1-390M+C/S-2:

Contents like KS1-390M+ with additional trays for further surveying accessories.

Options as shown in the following illustration:

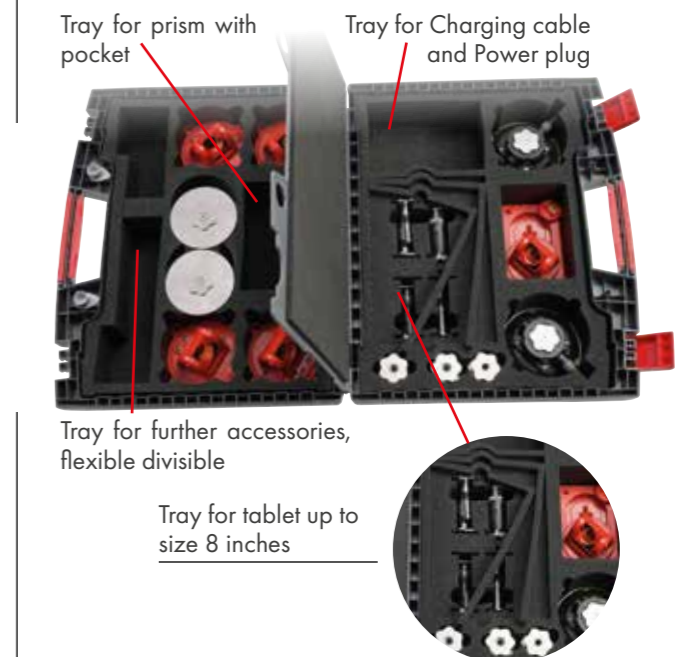

Fig. KS1-390M+C/S-2
Metrics: W 500 mm x H 420 mm x D 225 mm
Weight (without tablet an additional accessories): 7.8 kg

Suitcase Sets with Laser Scanner- or SLAM Targets

Ideal for 3D inside and outside measurements



Fig. (left) KS2 available for RSL420M, RSL422M, RSL452M, RSL453M
Metrics: W 390 mm x H 310 mm x D 200 mm
Weight: 4.5 kg

Fig. (right) KS2-2 available for RSL420M, RSL422M, RSL452M, RSL453M
Metrics: W 500 mm x H 420 mm x D 225 mm
Weight: 9 kg

Suitcase sets with laser scanner- or SLAM targets – perfectly coordinated equipment packaged to save space.

Suitcase KS2-422M or KS2-422M-2 with:

- 6 Laser Scanner Targets RSL420M or RSL422M
- 1 Mini Prism RSMP395M

Accessories

- 30 Fixed Points RSFP-X90
- 4 Fixed Points for power sockets RSFP-X90-30**

Suitcase KS2-452M or KS2-453M with:

- 6 Laser Scanner- and SLAM Targets RSL452M or RSL453M
- 1 Mini Prism RSMP395M

Accessories

- 30 Fixed Points RSFP-X90
- 4 Fixed Points for power sockets RSFP-X90-30**

Suitcase KS2-420M or KS2-422M-2 with:

- 4 Laser Scanner Targets RSL420M or RSL422M
- 1 Mini Prism RSMP395M

Accessories

- 50 Fixed Points RSFP-X90
- 4 Fixed Points for power sockets RSFP-X90-30**
- 2 Suction Cups RSSV-X90
- 3 Floor Stands RSFP-X98-1

Suitcase KS2-452M-2 or KS2-453M-2 with:

- 4 Laser Scanner- and SLAM Targets RSL452M or RSL453M
- 1 Mini Prism RSMP395M

Accessories

- 50 Fixed Points RSFP-X90
- 4 Fixed Points for power sockets RSFP-X90-30**
- 2 Suction Cups RSSV-X90
- 3 Floor Stands RSFP-X98-1



RSL420M/RSL422M



RSL452M/RSL453M

Laser Scanner Sphere Suitcase Set

Ideal for 3D inside and outside measurements



Fig. KS3-RSLB10M
Metrics: W 500 mm x H 420 mm x D 240 mm
Weight: 7.5 kg

Suitcase KS3-RSLB10M with:

- 6 Laser Scanner Spheres RSLB10M magnetic

Laser Scanner / SLAM Targets Suitcase Set

Safe and ready to hand - perfectly organised for precise 3D measurements and the use of drones

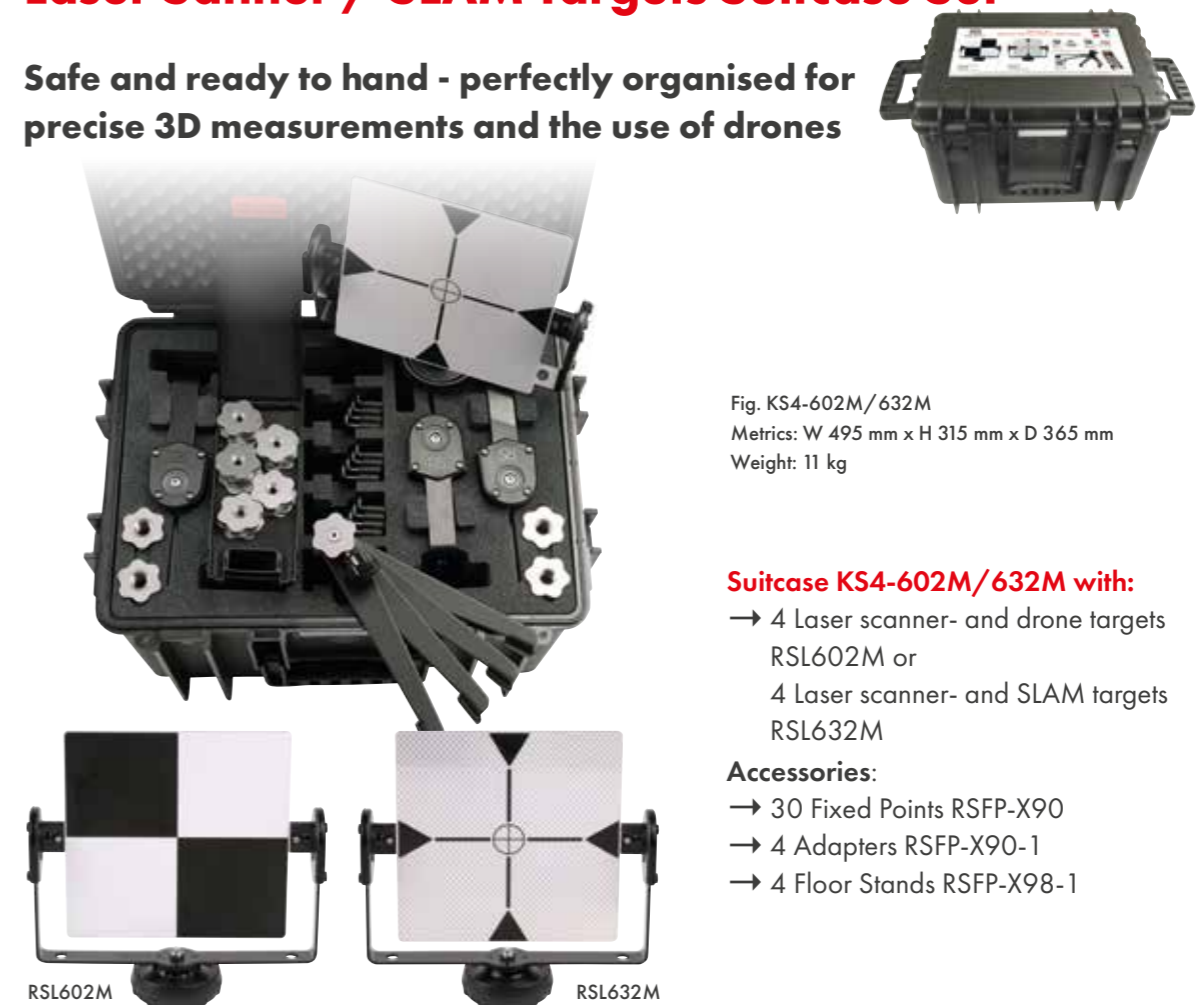

Fig. KS4-602M/632M
Metrics: W 495 mm x H 315 mm x D 365 mm
Weight: 11 kg

Suitcase KS4-602M/632M with:

- 4 Laser scanner- and drone targets RSL602M or 4 Laser scanner- and SLAM targets RSL632M

Accessories:

- 30 Fixed Points RSFP-X90
- 4 Adapters RSFP-X90-1
- 4 Floor Stands RSFP-X98-1

RSL602M

RSL632M

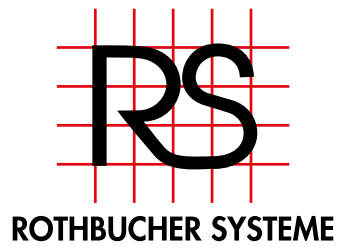

ROTHBUCHER SYSTEME



The RS Surveying Accessory System Proven millionfold – in use worldwide

Request our price list

Rothbucher Systeme
Reichenhaller Str. 109A
D-83435 Bad Reichenhall
www.smart-targets.com

Phone +49 (0) 8651 2749
Fax +49 (0) 8651 3090
Cell +49 (0) 171 7314961
info@smart-targets.com

